

Ziegler

Redefine Innovative Metering

Protector Trip Relays





An extensive range of electronic control products, providing continuous monitoring and protection of any electrical parameter. When the monitored parameter deviates from the desired set point limit, the relay will operate to prevent damage to the power asset. Designed to suit a wide variety of applications, the range offers both traditional and technologically advanced products, from single parameter units through to multifunctional microprocessor based protection relays.

This versatile range features a host of DIN rail or wall mounted protectors offering numerous trip functions for single and three phase power systems, including over and under voltage, current, frequency, three phase sequence, phase failure and phase balance. For the specific protection of generator sets, the range offers unbalanced current, reverse power flow, reverse VAr, syncro-check and under/over speed trip relay functions. Various DC models provide protection of battery and UPS systems, and a range of temperature protection products are ideal to prevent the damaging effects of overheating.

Features

- Continuous monitoring of any electrical parameter
- Monitoring for under and over current conditions
- Ensures load current is within generator capacity
- DIN rail or wall mounted
- Range of outputs and configurations
- Adjustable trip points, time delay and differentials
- LED trip indication
- Designed to avoid nuisance tripping

Benefits

- Protection of power assets
- Detection and isolation of faults
- Maintains supply continuity of healthy circuits
- High speed tripping to avoid damage

Applications

- Switchgear
- Distribution systems
- Generator sets
- Control panels
- Energy management
- Building management
- Utility power monitoring
- Process control
- Motor protection
- Equipment and network protection

Approvals

UL, CSA, BV and ABS Approvals

Contents

SPR System Protection Relay

Cost effective and space saving microprocessor based relay, offering system protection, control and measurement of three phase voltage and current, with twelve user definable relay outputs. UL Approvals.

RS232 to RS485 Serial Converter

Allows direct connection from the SPR system protection relay to SCADA or PC based systems.

373-ELR Earth Leakage Protection

For the continuous monitoring of fault current compared with user selectable leakage level, these DIN rail units offer single setpoint, relay contacts and LED earth leakage level indicators or alarms. UL approved, CSA compliant.

CBT-94F Core Balanced Current Transformers

Designed for use with the 373-ELR earth leakage protection relay. The range offers various case widths and apertures with a measurement range of up to 10A and a maximum 720V rated system voltage.

373-GFR Ground Fault Relay

This compact DIN rail ground fault relay allows the fault current to be continuously monitored and compared with the user selectable trip level. Ideally suited for any type of electrical equipment, specifically switchboards, generator sets and transformers. UL approved, CSA compliant.

Vector Shift and ROCOF Relay

A choice of DIN rail or panel mounted units offering ROCOF (rate of change of frequency) and Vector Shift protection against loss of mains at the generator site.

262 Series Panel Mounted Protector Trip Relays

Panel mounted AC current, AC voltage and frequency protector trip relays providing alarm, control or tripping functions when the measured parameter moves outside the setpoint limit.

250 Series DIN Rail and Wall Mounted

Single and three phase protector relays offering continuous surveillance of electrical parameters with adjustable set point limits, differentials and time delay settings. Provides an alarm or initiation signal when the measured parameter moves outside the setpoint limit. UL, CSA, BV and ABS Approvals.

Page

2 – 6

7

8 – 9

10

11 – 12

13 – 16

17 – 19

20 – 51



Features

Integrated protection, control, measurement and communication of up to 37 power parameters

Digital communications

Fully programmable VT and CT ratios

Simple menu driven interface

High quality backlit LCD display

True RMS measurement

3 phase, 3 wire or 4 wire unbalanced load options

18 protection relay functions

12 relay contacts outputs

Trip event history log

Watchdog relay

Benefits

Replaces numerous traditional protection relays

Significant cost savings

High accuracy

Remote monitoring

Investment protection

Delinquency avoidance

Compact and easy to configure

Time and space saving

Applications

G.59/1 Protection

General purpose system protection

Switchgear

Distribution systems

Generator sets

Control panels

Utility power monitoring

Motor protection

Cable protection

Feeder protection

Automatic transfer switches

Railway applications

Approvals

UL File No. E214283

CSA Compliant

Railtrack Certificate of Acceptance
PA05/1450. Scope: Protective Device
on Signalling Power Supply Systems

The SPR system protection relay is a microprocessor based panel mounted device offering protection, control, measurement and communication of up to 37 power parameters in a single package. The SPR monitors three phases of voltage and current and provides up to twelve user definable relay outputs. The high contrast 80 character backlit LCD display allows the user to monitor any of the measured parameters, inspect setpoint details and relay contact status. The setpoints and configuration are all fully programmable via the simple menu driven user interface. Remote monitoring of status information is achievable via the integral RS 485 communication port which supports Modbus RTU protocol. SPR is suitable for many diverse applications, providing cost effective protection of expensive power assets.

Operation

Using an alphanumeric display, the SPR is simple to operate via four buttons which configure and control the product, all parameters can be inspected or modified through front of panel menu selections. For security, alterations of any parameters can be disabled with up to four levels of password protection. The default display is the status screen, where the status of each of the relay contacts can be clearly identified, but a user-defined screen can be easily configured to display four lines of metering information. SPR can also be remotely monitored and fully controlled over the RS485 Modbus connection.

Output Relays

The SPR has up to twelve sets of form C change-over (NO+NC) relay contacts, each rated at 8 Amps 250V AC. These do not have fixed functions, allowing each relay to be configured to suit a specific application. Flexibility is the key to this product and any function, or combination of functions, can be assigned to any relay. With a choice of up to 18 protective trip functions, and 9 logical functions, SPR provides a cost-effective method of protection combined with significant space savings. If additional contact sets are required for any function, programmable logic allows the paralleling of as many additional contacts as are available. The standard product has eight relays, but for the most demanding applications, four additional relays can be supplied as an option. Each relay can be configured to energise or de-energise on trip (failsafe or non-failsafe operation), latch or self-reset, have its activity recorded in the event log, or trigger a common alarm, as required.

Watchdog Relay

Following comprehensive self diagnostic checks at power-up, and once correct operation has been verified, the dedicated change-over (NO+NC) relay contacts energise to indicate product availability. The microprocessor continuously monitors the relay system for healthy operation, and the contacts will de-energise if an internal fault is detected or the auxiliary supply is lost.

Event History Log

Every trip event can be selectively recorded in the history log. Up to 50 events are itemised by date and time stamp to a time resolution of 100ms, ideal for analysing the sequence of events leading up to a system fault. The internal real time clock has battery backup to maintain the correct time and date for many years, even if the product is not powered up.

Power Metering

True RMS measurements of up to 37 power measurements are continuously updated. The voltage, current and frequency signals are measured directly, while other parameters, such as Watts, VAr and VA, are computed from this data. Current inputs are given a very wide dynamic range in order to process overloads for time over current functions. Since the readings are true RMS, distorted waveforms are accurately measured, leading to excellent harmonic performance.

Digital Communications

The built-in RS485 communication port supports Modbus RTU protocol and offers metering of Phase Voltages, Phase Currents, Watts, VAr, VA, Phase Angle, Power Factor, Gen and Bus frequency, plus accessibility to all other features and functions available through the front panel. Relay status and system measurements can be interrogated, and relay parameters can be modified remotely. Remote metering is available using Crompton software.

Time Curves

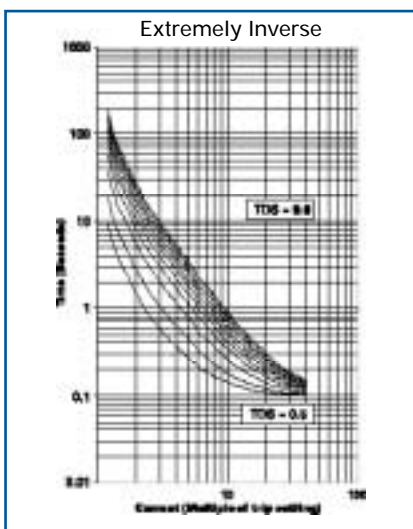
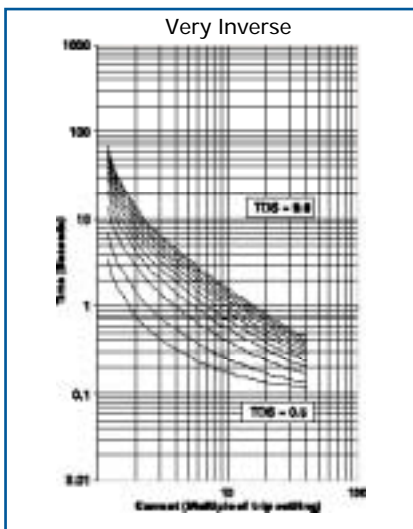
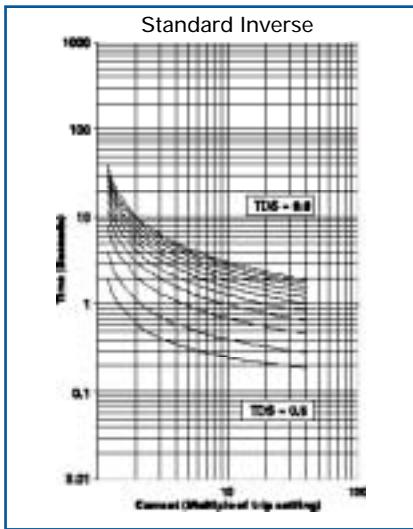

Relay Trip Parameters and Functions

ANSI	Description	Parameter	Range/Resolution/Accuracy
25	Synchronism-Check Monitoring	Phase Difference	2 to 20 degrees / 0.1 degrees / $\pm 1^\circ$
		Slip Frequency	0.1 to 1 Hz / 0.01 Hz / ± 0.03 Hz of nominal
		Voltage Difference	0 to 20% / 0.1 V / $\pm 2\%$ of nominal
25D	Synchronism-Check monitoring with Dead Bus feature	Minimum Volts Level	5 to 119% / 0.1 V / $\pm 1\%$ of nominal
		Phase Difference	2 to 20 degrees / 0.1 degrees / $\pm 1^\circ$
		Slip Frequency	0.1 to 1 Hz / 0.01 Hz / ± 0.03 Hz of nominal
		Voltage Difference	0 to 20% / 0.1 V / $\pm 2\%$ of nominal
27	Under Voltage Relay	Dead Bus Voltage	5 to 50% / 0.1 V / $\pm 1\%$ of nominal
		Voltage Setpoint	5% to 119% V / 0.1 V / $\pm 1\%$ of nominal
320	Directional Active Power (Forward Watts)	Diff	1 to 15% V / 0.1 V / $\pm 1\%$ of nominal
		Power Setpoint	3 to 120% W / 0.1 W / $\pm 3\%$ of nominal
32R	Directional Active Power (Reverse Watts)	Diff	1 to 15% W / 0.1 W / $\pm 1\%$ nominal
		Power Setpoint	3 to 120% W / 0.1 W / $\pm 3\%$ of nominal
37	Under Current Relay	Diff	1 to 15% A / 0.01 A / $\pm 1\%$ of nominal
		Current Setpoint	30 to 300% A / 0.01 A / $\pm 2.5\%$ of nominal
40Q	Directional Reactive Power (Loss of Excitation / Reverse VAR)	Diff	1 to 15% VARs / 0.1 VARs / $\pm 1\%$ of nominal
		Power Setpoint	3 to 120% VARs / 0.1 VARs / $\pm 4\%$ of nominal
46	Unbalanced Current Relay	Diff	1 to 15% A / 0.01 A / $\pm 1\%$ of nominal
		Current Setpoint	5 to 120% A / 0.01 A / $\pm 2.5\%$ of nominal
47	Phase Sequence Relay	No Parameters	
47	Unbalanced Voltage Relay	Diff	1 to 15% V / 0.1 V / $\pm 1\%$ of nominal
		Voltage Setpoint	1 to 25% V / 0.1 V / $\pm 2\%$ of nominal
50	Instantaneous Over Current Relay	Diff	1 to 15% A / 0.01 A / $\pm 1\%$ of nominal
		Current Setpoint	30 to 300% A / 0.01 A / $\pm 2.5\%$ of nominal
50N	Instantaneous Neutral Over Current Relay	Diff	1 to 15% A / 0.01 A / $\pm 1\%$ of nominal
		Current Setpoint	30 to 300% A / 0.01 A / $\pm 2.5\%$ of nominal
51	AC Time Over Current Relay with 3 Time Curves	Time Curves	Standard Inverse, Very Inverse, Extremely Inverse
		Time Dial	0.1 to 9.9 sec / 0.1 seconds / -
		Current Setpoint	5 to 120% A / 0.01 A / $\pm 2.5\%$ of nominal
51V	AC Time Over Current with Voltage Restraint	Time Curve	Standard Inverse, Very Inverse, Extremely Inverse
		Time Dial	0.1 to 9.9 sec / 0.1 seconds / -
		Restraint Voltage	80 to 120% / 0.1 V / $\pm 1\%$ of nominal
		Current Setpoint	5 to 120% A / 0.01 A / $\pm 2.5\%$ of nominal
51G	Neutral Ground Fault Relay	Time Curve	Long time standby Earth Fault curve
		Time Dial	0.1 to 9.9 sec / 0.1 seconds / -
		Current Setpoint	5 to 120% A / 0.01 A / $\pm 3\%$ of nominal
59	Over Voltage Relay	Diff	1 to 15% / 0.1 Volts / $\pm 1\%$ of nominal
		Voltage Setpoint	5 to 120% V / 0.1 V / $\pm 1\%$ of nominal
810	Over Frequency Relay	Diff	0.1 to 10 Hz / 0.01 Hz / ± 0.03 Hz of nominal
		Frequency Setpoint	40 to 70 Hz / 0.01 Hz / ± 0.03 Hz of nominal
81U	Under Frequency Relay	Diff	0.1 to 10 Hz / 0.01 Hz / ± 0.03 Hz of nominal
		Frequency Setpoint	40 to 70 Hz / 0.01 Hz / ± 0.03 Hz of nominal

All trip functions feature latching, alarm and invert controls, plus adjustable time delay 0 to 30 seconds, resolution 0.1 seconds.

In addition to the 18 electrical trip functions, SPR also offers 9 logical functions which can be used to create additional trip combinations, selective lockout, or to optimise the physical relay wiring in the application. Logic functions accept their input signals from the status of up to 3 trip relays. The following functions are available: Logical AND, OR, NAND, NOR, XOR, Vote, Discrepancy, Alarm and Unacknowledged Alarm.

\ lgi ngt

Ü^â^~â^ÁQ} [çääç^ÁT^c^iâ *



Specification

Input	
Nominal Input Voltage	57.7 to 277V L-N (100 to 480V L-L)
Max Continuous Input Voltage	1.2 x Nominal
Max Short Duration Input Voltage	2 x Nominal (1 second)
System VT ratio (primary)	Any value up to 400 kV
Nominal Input Voltage Burden	< 0.2 VA
Nominal Input Current	5A (1A option)
System CT Ratio (primary)	Any value up to 10 kA
Max Continuous Input Current	2 x Nominal
Max Short Duration Input Current	20x Nominal (1 second)
Nominal Input Current Burden	< 0.6 VA
Auxiliary	
Nominal Supply Voltage	24V DC (10.6 to 55V DC absolute)
Supply Burden	< 20 VA
RS485 Communication	
Protocol	Modbus RTU, two wire half duplex
Baud Rates	2400, 4800, 9600, 19200
Parity / Stop Bits	Odd, Even, None / 1 or 2
Response Time	Typical 80ms. Maximum 150ms
Relay Outputs	
Watchdog Relay Outputs	1
User Programmable Relays	8 or 12
Relay Contact Type	Volts-free change-over (form C)
Relay Contact Rating	8 Amp (resistive) 250V AC
Relay Make Current	30 Amp (4 sec @ <10% duty cycle)
Rated Breaking Capacity	2000 VA
Relay Mechanical Life	30 Million Operations
Relay Contact Life	B300/120V AC/70°C to UL508 B300/240V AC/70°C to UL508
Measuring Ranges	
Voltage	20 .. 120% of nominal
Current	20 .. 120% of nominal (functional 5 .. 500%)
Frequency	45 .. 66 Hz
Power Factor	0.5 .. 1 .. 0.5 Importing or Exporting
Watts	5 .. 120%
Enclosure	
IP Rating	IP54 with panel gasket (supplied)
Material	Zinc passivated steel with polycarbonate front panel
Terminals	Removable shrouded screw clamp terminals
Operating Temperature	0°C to +50°C (Optional -20°C to +60°C)
Storage Temperature	-20°C to +70°C
Relative Humidity	95% non-condensing
Shock	30g in 3 planes
Vibration	10 to 150 Hz, @ 1g amplitude
Dimensions	200mm (7.87") wide, 106mm (4.17") high, 176mm (6.93") deep.
Panel Cut Out	187mm wide (7.36") x 93mm (3.66") high
Weight	< 3 kg
Compliant With	G.59/1, BS EN 50081-1, BS EN 50082-2, BS EN 61010-1, BS EN 60255-4, BS EN 60255-6, ANSI/IEEE C37.90 UL508, UL and CSA File No: E214283
Railtrack Certificate of Acceptance	PA05/1450 Protective Device on Signalling Power Supply Systems

Measurement, Display and Communication

SPR offers configuration, display and communication of up to 37 true RMS power measurements

Voltage L1-L2
Voltage L2-L3
Voltage L3-L1
Voltage L1-N
Voltage L2-N
Voltage L3-N
System Voltage (average)

Current L1
Current L2
Current L3
System Current (average)
System Current (sum)
Neutral Current
Ground Current

System Watts
Watts L1
Watts L2
Watts L3

System VAR
VAr L1
VAr L2
VAr L3

System VA
VA L1
VA L2
VA L3

Power Factor
PF L1
PF L2
PF L3

Phase Angle
PA L1
PA L2
PA L3

Gen Frequency

Bus Frequency

Gen-Bus Angle

lgi ngt

Ü^â^_â^ÁQ} [çacç^Á^c^i_â^*



Order Code Example:

SPR-013W-PQLS-C5-BD-12-MB

SPR 3 phase 3 wire, 120V L-L, 5A, 50Hz,
24V DC auxiliary power with RS485
Modbus, 12 relays

SPR-SOFT Communication and Programming Software

The software configuration package allows the user to configure and monitor the operation of the SPR system protection relay through a Windows style user interface. It allows the user to load and save the configuration to and from a hard disk on a PC, and to send and retrieve configuration settings to and from up to 31 SPR units. Communication is achieved with a Modbus connection to a COM port on the PC via an RS485/RS232 converter.

The software configurator is designed to display and set up the parameters of the SPR relays, to monitor the status of the selected SPR, and to provide status of the power supplies the SPR is monitoring. A separate configuration page is provided for setting the parameters of each relay.

The configurator incorporates separate pages to display measurements, relays and event data. When one of these pages is selected in on-line mode, the configurator interrogates the selected SPR every few seconds to obtain the data required for that page. In addition, there is an option to bring up the measurements page from any other page if the SPR raises an alarm.

Product Codes

Product Code	Product Configuration
SPR-013W-*LS-**-BD-***-MB	SPR 3 phase 3 wire, 5A, 24V DC auxiliary power with RS485 Modbus
Input Voltage*	
PK	100 Volts L-L
PM	110 Volts L-L
PO	115 Volts L-L
PQ	120 Volts L-L
RM	208 Volts L-L
RU	380 Volts L-L
RW	400 Volts L-L
SB	415 Volts L-L
SH	440 Volts L-L
SE	480 Volts L-L

Product Code	Product Configuration
SPR-014W-*LS-**-BD-***-MB	SPR 3 phase 4 wire, 5A, 24V DC auxiliary power with RS485 Modbus
Input Voltage*	
NV	57.7 Volts L-N
NX	63.5 Volts L-N
PA	69.0 Volts L-N
PK	100 Volts L-N
PM	110 Volts L-N
PQ	120 Volts L-N
P7	127 Volts L-N
R4	220 Volts L-N
RQ	230 Volts L-N
RR	240 Volts L-N
RS	250 Volts L-N
R6	277 Volts L-N

Frequency**	
C5	50Hz
C6	60Hz
Relays***	
08	8 x relays
12	12 x relays

Optional Accessories	
SPR-POWER-A1	Auxiliary Power Supply Unit 85-264V AC & 100-375V DC
SPR - SOFT	Communication and Programming Software
9D-485	RS232 to RS485 Serial Converter

kgi ngt

Ü^â^_â^ÁQ}[çää^Á^c^!â *

SPR Dimensions

Front Display Area

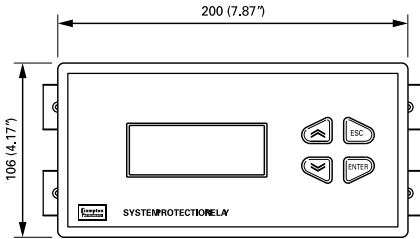

Side View

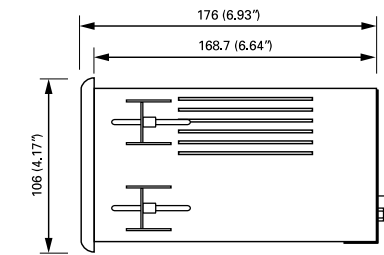

Panel Cutout

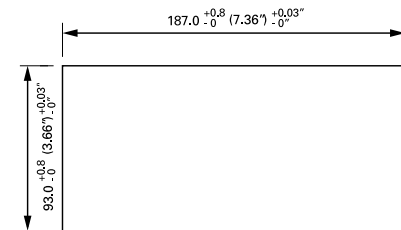

Dimensions with Optional SPR-POWER Unit

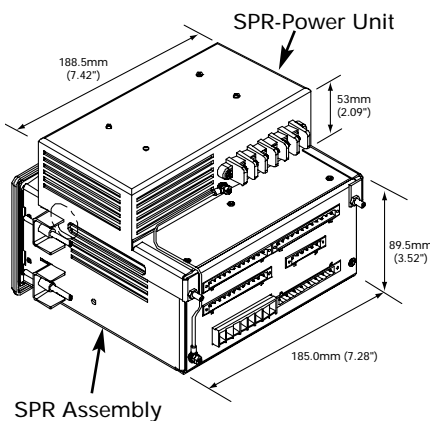

Connections

The four current transformer inputs are fully isolated from ground and from each other, allowing the SPR to be used as an intermediate device or connected to a common ground as required. All electrical connections are made using two-part removable connecting blocks.

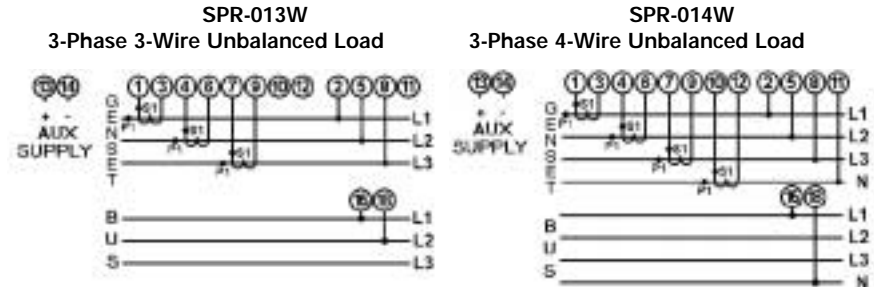

Auxiliary Supply

Designed to operate from 24V D.C. nominal engine batteries, operating normally at reduced voltage when the engine is cranking, and increased voltage when the batteries are on charge. The switched mode auxiliary power supply has a very wide operating range of 10.6 to 55 volts. A separate auxiliary module is available for other auxiliary voltages.

Safety / Ground Connections

The ground stud on the rear panel should be connected to a clean ground. For safety reasons, CT secondary connections should be grounded according to appropriate codes of practice.

SPR-POWER Switched Mode Power Supply

The SPR is designed to operate with a nominal 24 volt DC auxiliary supply, however, the SPR-POWER unit will derive a suitable supply for applications utilising 85 to 264V AC, 45-66 Hz or 100 to 375V DC. This switched mode power supply is simply attached to the System Protection Relay (SPR) chassis via two threaded screws.

Input	
Input Voltage	85 to 264V AC, 45-66 Hz 100 to 375V DC
Burden	< 36 VA
Output	
Output Voltage	24 volts DC @ 600mA
Environmental	
Operating Temperature	-20 to +50°C
Storage Temperature	-30 to +80°C
Relative Humidity	0 .. 95% non condensing
Enclosure	
Style	Custom design to mount directly on SPR
Material	Zinc passivated steel
Terminals	Barrier terminal strip 6-32 binding head screw
Grounding	Dedicated grounding stud provided

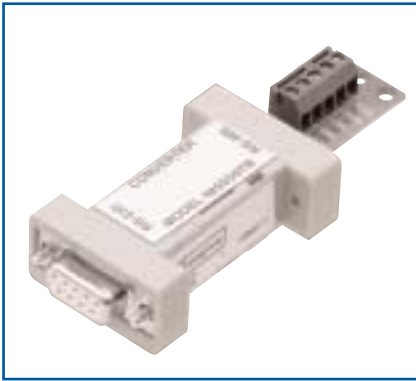

The SPR system protection relay features an integral RS485 communication port, allowing direct connection to SCADA systems via Modbus RTU protocol. However, the SCADA systems or PC based equipment used for remote monitoring of electrical and power parameters often incorporate RS232 communication ports, therefore conversion to RS485 is necessary. The 9D-485 module is a simple non-isolated two wire half duplex RS485 converter which fits into any PC based system.

This port powered two-channel module converts the TD and RD RS232 lines to balanced half-duplex RS485 signals via a 9 way female D type connector on the RS232 side, and a screw clamp terminal block connector on the RS485 side. The module has an internal connection to prevent data transmitted from the RS232 port from being echoed back to the RS232 port.

Features

- Direct connection to PC RS232 serial port
- 9 way female D type connector
- Port powered or externally powered
- Balanced RS485 signals
- Very high noise immunity
- Two wire half duplex
- Prevents echo-back to RS232

Compatible With

SPR System Protection Relay

Applications

- PC based communication systems
- SCADA Systems
- PLC interfacing
- Energy management systems

Operation

The 9D-485 module is powered from two RS232 output handshake lines. However, an external 12V DC power supply can be connected to two terminals on the RS485 connector if no handshake lines are available. When using an external supply, the supply should be connected only to specifically labeled power inputs (power jack, terminal block, etc.).

Note: Connecting an external power supply to the handshake lines may damage the unit.

Although the 9D-485 module uses handshake lines to power the converter, no handshaking is required to control the RS485 driver. The RS485 driver is automatically enabled during each spacing state on the RS232 side. During the marking or idle state, the RS485 driver is disabled and the data lines are held in the marking state by pull-up and pull-down resistors.

Specification

Protocols Supported	Modbus RTU
Internal Power	2 x RS232 handshake lines
External Power	12V DC to RS485 side if handshake lines unavailable
Current Draw	35mA max when externally powered
RS232 Connector	9 way female D Type
RS232 Signals	Passes through pins 3 (TD) and 2 (RD) Pins 7 (RTS) and 8 (CTS) are tied together Pins 4 (DTR), 6 (DSR), and 1 (CD) are tied together
RS485 Connector	Screw clamp terminal block
RS485 Signals	Automatic control circuit enables driver only when transmitting
RS485 Receiver	Disabled when transmitting to prevent echo back to RS232
RS485 Communications	Half duplex two wire operation
RS485 Baud Rate	Up to 115.2k baud
Maximum Distance	Up to 1200 meters (4000 feet)
Multidrop Connections	Up to 32
Compliant With	EN 55022, EN 61000-6-1, EN 61000-4-2, EN 61000-4-3, EN 61000-4-4, EN 61000-4-5, EN 61000-4-6, EN 61000-4-8, EN 61000-4-11
Dimensions	89mm long x 34mm wide x 17mm deep 3.50" long x 1.34" wide x 0.67" deep

Product Code

9D-485	Port powered RS232 to RS485 serial converter
---------------	--



Residual current devices are used to detect potentially dangerous earth fault currents before damage is caused. An undetected fault current may lead to cables overheating, which could start a fire. If high fault currents are involved, hazardous voltages may also appear on earthed equipment, putting lives at risk. The 373-ELR earth leakage protection relay allows the fault current to be continuously monitored and compared with the user selectable leakage level. Should the leakage exceed this level, the relay will trip to indicate a fault condition. With a very fast response time of under 40ms, the supply can be disconnected before serious damage can occur. This product is intended to provide a high degree of earth leakage protection and monitoring for any electrical equipment, specifically motors and their control gear, generator sets and transformers.

Description

The 373-ELR range offers a standard DPCO version, incorporating a single setpoint, LED leakage level indicator and double pole change over relay contacts. The default relay operation is to de-energise on trip, however, relay operation can be reversed to energise on trip by fitting a wire link between two terminals. For additional functionality, an optional pre-alarm relay version is available where the main setpoint relay has two single pole change over contacts, one of which will de-energise on trip function and the other will de-energise when the leakage level reaches 60% of the selected setting.

This protector does not check the continuity of any part of the earthing circuit, it is designed for secondary protection due to the externally connected current transformer and contactor components. Life protection devices require an integral CT and main contactor.

Operation

The 373-ELR features two incremental rotary selector switches on the front panel and a series of LED annunciators. The 10 position trip current switch offers selectable earth leakage current settings from 30mA to 10 Amps, and the 16 position time delay setpoint switch offers additional delay for fault discrimination, selectable from 0 to 10 seconds. When the 30mA trip current leakage is selected, the time delay is disabled. Once the trip current and time delay selections have been made, a green LED provides indication of mains healthy supply. The red LED will automatically illuminate if the pre-set leakage level has been exceeded, after any selected time delay.

The unit also incorporates a bargraph of 5 yellow LEDs providing indication of the level of leakage in 20% increments. When all 5 LEDs are illuminated the leakage level has reached 100% of the setpoint setting. The enhanced pre-alarm single pole change over relay contact version also incorporates a red LED providing indication that the level of leakage has reached 60% of the selected range, and that the pre-alarm relay has operated.

The unit features a combined reset and test button. A short press of the button will reset the unit after a trip, and one long press initiates an electronic confidence check. The relay latches on to a fault until the test/reset button is pressed or the auxiliary power is removed. The relay will de-energise on trip (fail safe) as standard. Fitting a link between two terminals will select energise on trip.

Analogue Outputs

The 373-ELR unit incorporates an 0/1mA analogue output which equals 0 to 100% of the selected tripping level. It can be used to drive an external test meter or panel meter, thus providing measurements for test commissioning and a useful indication of potential problems. The analogue output also enables fault level diagnosis to be communicated into building management or intelligent SCADA systems, whereby insulation deterioration can be monitored over a period of time and preventative maintenance arrangements made prior to expensive equipment failure.

Core Balanced Current Transformers

The leakage current is determined by passing the phase conductors (and neutral if present) through a core balanced current transformer, all supply cables must pass through the same aperture. The current transformers sum the currents flowing into and back from the load. Ideally, the load will have no leakage current, so current flow through the CT will completely cancel out. For example, 100 Amps flowing into load and 97 Amps flowing back provides an output of 3 Amps. Crompton offer a full range of core balanced current transformers suitable for use with 373-ELR earth leakage protection relays.

Features

- Precision digital settings
- LED bargraph display
- 10 selectable trip levels – 30mA to 10A
- 16 selectable time delay – 0ms to 10 seconds
- Less than 40ms response time
- 0-1mA analogue output
- 8 Amp 250V rated relay contacts
- User selectable energise or de-energise link
- Double pole change over relay
- Single pole pre-alarm option

Benefits

- DIN rail 43880 enclosure
- Switched mode supply accepts a wide range of auxiliary voltages
- Detects residual current flow
- Isolation of faulty circuits
- Insulation monitoring
- Advanced warning of faults
- Complementary range of core balanced CTs
- Protection of expensive power assets

Applications

- Switchgear
- Distribution systems
- Generator sets
- Control panels
- Building management
- Utility power monitoring
- Process control
- Motor protection
- Transformer protection

Approvals

- UL 3111-1 File No: E203000
- CSA compliant
- EMC and LVD

Dimensions to DIN 43880

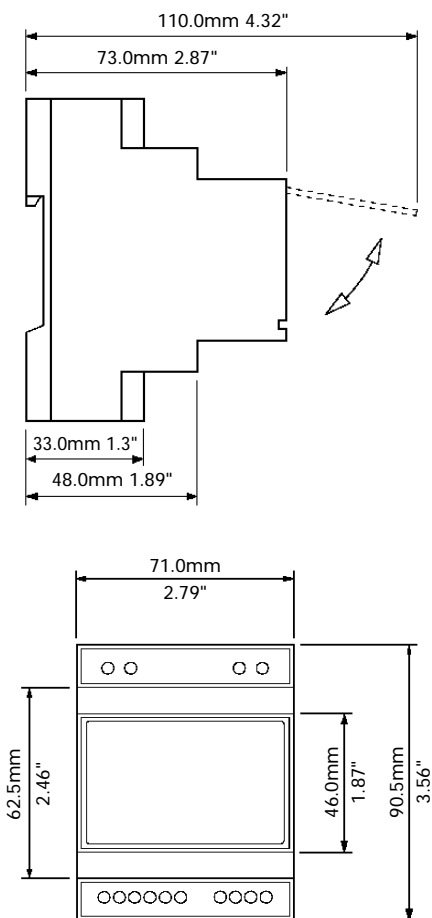

Connections

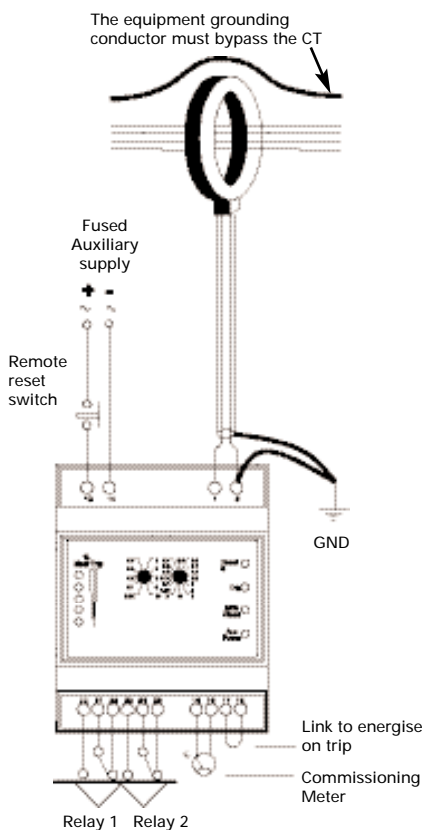

Specification

Measuring Input	From core balanced current transformer
Overload	20 x nominal for 1 second
Frequency	50Hz or 60Hz $\pm 10\%$
Auxiliary Voltage	12 - 48V D.C. , 24 - 48V A.C & D.C.or 100 - 250V A.C.& D.C.
Auxiliary Burden	Less than 1.5 Watts
Trip Current Settings	Selectable 30mA, 100mA, 200mA, 300mA, 500mA, 1A, 2A, 3A, 5A, 10A
Trip Accuracy	50% < trip point current <100% in accordance with IEC 1543
Trip Response Time	< 40ms (at 5 x rated trip current, ignoring the selected time delay)
Time Delay Setpoints	Selectable 0ms, 50ms, 100ms, 150ms, 200ms, 300ms, 400ms, 500ms, 600ms, 700ms, 800ms, 900ms, 1 second, 2 seconds, 5 seconds, 10 seconds. When 30mA leakage is selected, the time delay is disabled
Indication	5 yellow LED bargraph for leakage levels Red LED indicated trip function Green LED indicated auxiliary power presence Red LED pre-alarm indication (SPCO version only)
Relay Contacts	Standard: Double pole change over Option: 2 single pole change over (pre alarm and main alarm)
Relay Contact Rating	8 Amps at 250V A.C. 8 Amps at 30V D.C. resistive
Relay Mechanical Life	> 100,000 operations
Analogue Output	0 to 1 mA = 0 to 100% of selected tripping level. Compliance 1V, accuracy 10%
Enclosure Style	DIN 43880, rail width 70mm
Compliant With	EMC and LVD, UL 3111-1 File No: E203000, CSA 22.2/1010.1-92 BSEN 50081-1, BSEN 50082-2, IEC 60255-22-1 (BS5992), IEC 60255-11, BSEN 61543 (IEC 1543), BSEN 61010 (IEC 1010), EN 60068 (IEC 68)
Material	Flame retardant UL94V0
Terminals	1 to 4 mm ² solid or stranded conductors. IP20 protection
Operating Temperature	-10 to +60°C
Storage Temperature	-20 to +70°C
Relative Humidity	0 .. 95% non condensing
Weight	<250g
Dimensions	71mm wide x 90.5mm high x 73mm deep 2.79" wide x 3.56" high x 2.87" deep

Product Codes - Double Pole Change Over Relay

Frequency	Auxiliary Supply	Catalogue No.
50Hz	12-48V DC	373-ELRW-CBC5-A1-ST
50Hz	24-48V AC & DC	373-ELRW-CBC5-A2-ST
50Hz	100-250V AC & DC	373-ELRW-CBC5-A3-ST
60Hz	12-48V DC	373-ELRW-CBC6-A1-ST
60Hz	24-48V AC & DC	373-ELRW-CBC6-A2-ST
60Hz	100-250V AC & DC	373-ELRW-CBC6-A3-ST

Product Codes - Pre-Alarm Single Pole Change Over Relay

Frequency	Auxiliary Supply	Catalogue No.
50Hz	12-48V DC	373-ELRW-CBC5-A1-PA
50Hz	24-48V AC & DC	373-ELRW-CBC5-A2-PA
50Hz	100-250V AC & DC	373-ELRW-CBC5-A3-PA
60Hz	12-48V DC	373-ELRW-CBC6-A1-PA
60Hz	24-48V AC & DC	373-ELRW-CBC6-A2-PA
60Hz	100-250V AC & DC	373-ELRW-CBC6-A3-PA



The CBT-94F series of core balanced current transformers are exclusively for use with our 373-ELR earth leakage protection relay. The extremely sensitive toroidal core and secondary winding are encapsulated by a self extinguishing case providing excellent mechanical strength, protection from damage, and electrical insulation.

Description

Residual current devices are used to detect potentially dangerous earth fault currents before damage is caused. An undetected fault current may lead to cables overheating, which could start a fire. If high fault currents are involved, hazardous voltages may also appear on earthed equipment, putting lives at risk. An earth leakage protection relay is intended to provide a high degree of protection and monitoring for any electrical equipment, specifically motors and their control gear, generator sets and transformers. The leakage current is determined by passing the phase conductors (and neutral if present) through a core balanced current transformer.

Operation

Primary conductors should be grouped together and fed through the current transformer aperture. It is essential that each conductor passes through the device in the same direction. Each phase conductor (and neutral if present) must pass through the current transformer. The current transformers sum the currents flowing into and back from the load. Ideally, the load will have no leakage current, so current flow through the CT will completely cancel out. For example, 100 Amps flowing into load and 97 Amps flowing back provides an output of 3 Amps.

The equipment grounding conductor must always bypass the current transformer. The connections between the current transformer and protector should be kept as short as possible to minimise signal noise. For best results, use screened cable, with the screen grounded at the protector.

Specification

System Voltage	720V maximum
Test Voltage	3kV AC for 1 minute
System Frequency	50Hz or 60Hz
Primary Ratings	From 30mA to 10A
Secondary Terminals	Protected to IP20
Operating Temperature	-10° C to +50° C
Enclosure	UL94V0 flame retardant plastic
Compliant With	IEC185, VDE 0414
Mounting Hardware	Steel mounting feet for wall or base mounting

Product Codes and Dimensions

Aperture Dim E	Dim A	Dim B	Dim C	Dim D	Catalogue No.
35mm	100mm	79mm	26mm	48.5mm	CBT-94F-035
70mm	130mm	110mm	32mm	66mm	CBT-94F-070
105mm	170mm	146mm	38mm	94mm	CBT-94F-105
140mm	220mm	196mm	49mm	123mm	CBT-94F-140
210mm	299mm	284mm	69mm	161mm	CBT-94F-210
300mm	400mm	380mm	-	-	CBT-94F-300

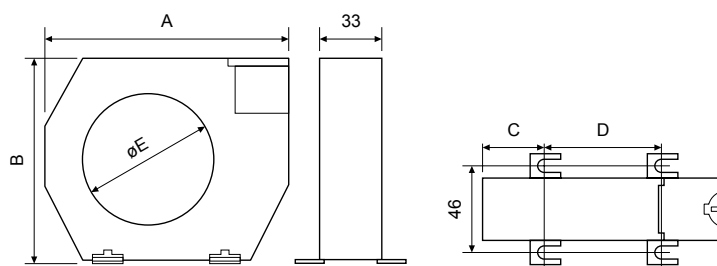

Features

- Leakage measurement range 0-10 Amps
- 6 models available
- Integral wire sealable terminal cover
- Flame retardant high impact moulded case

Benefits

- Reduction of high currents for ease of metering
- Wide operating temperature -10° C to +50° C
- Steel mounting feet supplied
- Long product life

Applications

- Switchgear
- Distribution systems
- Generator sets
- Control panels
- Motor protection
- Transformer protection
- Overload protection

Approvals

- IEC 185
- VDE 0414



The 373-GFR is designed to detect dangerous ground fault currents before damage is caused to expensive power assets. An undetected fault current may lead to cables overheating, which could start a fire. If high fault currents are involved, hazardous voltages may also appear on grounded equipment, putting lives at risk. The 373-GFR ground fault relay allows the fault current to be continuously monitored and compared with the user selectable trip level. Should the fault exceed this level, the relay will trip to indicate a fault condition. With a very fast response time of under 40ms, the supply can be disconnected before serious damage can occur. This product is intended to provide a high degree of ground fault protection and monitoring for any type of electrical equipment, specifically switchboards, generator sets and transformers.

Features

- Precision digital settings
- LED bargraph display
- 10 selectable trip levels – 100 to 1200 Amps
- 16 selectable time delay – 0ms to 10 seconds
- Less than 40ms response time
- 0-1mA analogue output
- User selectable input range of 0.2mΩ or 2mΩ
- User selectable latching/self-resetting
- Single pole change over relay
- 8 Amp 250V rated relay contacts

Benefits

- DIN rail 43880 enclosure
- Switched mode supply accepts a wide range of auxiliary voltages
- Isolation of faulty circuits
- Insulation monitoring
- Advanced warning of faults
- Protection of expensive power assets
- Current transformer not required

Applications

- Switchgear
- Distribution systems
- Generator sets
- Control panels
- Utility power monitoring
- Transformer protection

Approvals

- UL 3111-1 File No: E203000
- CSA compliant
- EMC and LVD

Operation

The 373-GFR offers a single pole change over relay contact incorporating a single setpoint, which will de-energise on trip. The relay senses the ground current by measuring the voltage developed across the N-G link impedance under a fault condition. Link selection of two standard N-G impedances, 0.2mΩ or 2mΩ. This is a very cost effective method, since a current transformer is not required.

The 373-GFR features two incremental rotary selector switches on the front panel and a series of LED annunciators. The 10 position trip current switch offers selectable ground fault current settings from 100 to 1200 Amps, and the 16 position time delay setpoint switch offers additional delay for fault discrimination, selectable from 0 to 10 seconds.

Once the trip current and time delay selections have been made, a green LED provides indication of mains healthy supply. The red LED will automatically illuminate if the pre-set fault level has been exceeded, after any selected time delay. The unit also incorporates a bargraph of 5 yellow LEDs providing indication of the level of fault in 20% increments. When all 5 LEDs are illuminated the fault level has reached 100% of the setpoint setting.

The unit features a combined reset and test button. A short press of the button will reset the unit after a trip, and one long press initiates an electronic confidence check. The relay latches on to a fault until the test/rest button is pressed or the auxiliary power is removed. However, automatic reset can be achieved by fitting a wire between two terminals. The relay will de-energise on trip (fail safe) as standard.

Analogue Outputs

The 373-GFR unit incorporates an 0/1mA analogue output which equals 0 to 100% of the selected tripping level. It can be used to drive an external test meter or panel meter, thus providing measurements for test commissioning and a useful indication of potential problems. The analogue output also enables fault level diagnosis to be communicated into building management or intelligent SCADA systems, whereby insulation deterioration can be monitored over a period of time and preventative maintenance arrangements made prior to expensive equipment failure.

Product Codes – Single Pole Change Over Relay

Frequency	Auxiliary Supply	Catalogue No.
50Hz	12-48V DC	373-GFRW-SHC5-A1-SP
50Hz	24-48V AC/DC	373-GFRW-SHC5-A2-SP
50Hz	100-250V AC/DC	373-GFRW-SHC5-A3-SP
60Hz	12-48V DC	373-GFRW-SHC6-A1-SP
60Hz	24-48V AC/DC	373-GFRW-SHC6-A2-SP
60Hz	100-250V AC/DC	373-GFRW-SHC6-A3-SP



Dimensions to DIN 43880

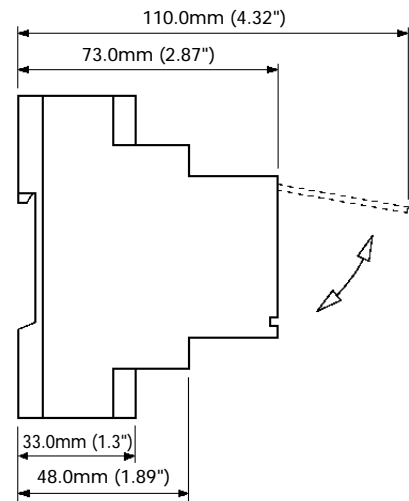

Specification

Measuring Input	A.C. voltage developed across N-G link
Measuring Range	0.2Ω or 2Ω shunt impedance link selectable
Overload	Maximum input voltage 600V
Frequency	50/60Hz
Auxiliary Voltage	12 - 48V D.C. , 24 - 48V A.C & D.C.or 100 - 250V A.C.& D.C.
Auxiliary Burden	Less than 1.5 Watts
Trip Current Settings	Selectable 100A, 150A, 200A, 250A, 300A, 450A, 600A, 750A, 800A, 1200A
Trip Accuracy	50% < trip point current ≤100% in accordance with IEC 1543
Trip Response Time	< 40ms (at 5 x rated trip current, ignoring the selected time delay)
Time Delay Setpoints	Selectable 0ms, 50ms, 100ms, 150ms, 200ms, 300ms, 400ms, 500ms, 600ms, 700ms, 800ms, 900ms. 1 second, 2 seconds, 5 seconds, 10 seconds.
Indication	5 yellow LED bargraph for fault levels Red LED indicated trip function Green LED indicated auxiliary power presence
Relay Contacts	Single pole change over (SPCO or NO+NC) contacts
Relay Contact Rating	8 Amps at 250V A.C. 8 Amps at 30V D.C. resistive
Relay Mechanical Life	> 100,000 operations
Analogue Output	0 to 1 mA = 0 to 100% of selected tripping level. Compliance 1V, accuracy 10%
Enclosure Style	DIN 43880, rail width 70mm
Compliant With	EMC and LVD, UL 3111-1 File No: E203000, CSA 22.2/1010.1-92, BSEN 50081-1, BSEN 50082-2, IEC 60255-22-1 (BS5992), IEC 60255-11, BSEN 61543 (IEC 1543), BSEN 61010 (IEC 1010), EN 60068 (IEC 68)
Material	Flame retardant UL94V0
Terminals	1 to 4 mm ² solid or stranded conductors. IP20 protection
Operating Temperature	-10 to +60°C
Storage Temperature	-20 to +70°C
Relative Humidity	0 .. 95% non condensing
Weight	<250g
Dimensions	71mm wide x 90.5mm high x 73mm deep 2.79" wide x 3.56" high x 2.87" deep

Connections

Install the neutral to ground shunt resistor in a suitable location. Connect the shunt sense wires directly to terminals N (neutral side) and G (ground side) on the relay. Cabling between the shunt resistor and the ground fault relay should be kept to a minimum.

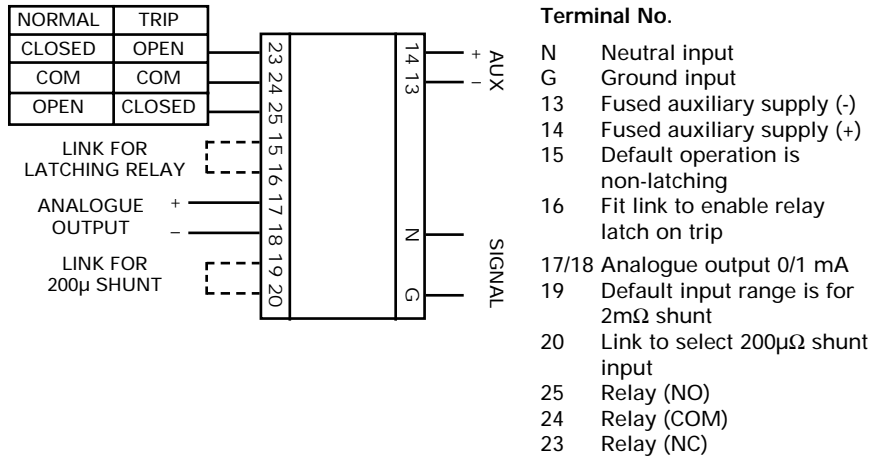

lgi ngt

Ü^â^_â^ÁQ} [çacç^Á^c^!â *



The Vector Shift and ROCOF protection relay is designed for applications where a generator is running parallel with a mains supply either from a utility or other generators. The relay will detect disconnection of a generator from the network, (islanding of an embedded generator) and trip the generator's circuit breaker. It is specifically designed to protect the mains from the potential damaging effects of reconnection whilst out of synchronism, and the supply of power to local lines without authority. The relay is available in two case styles, both of which simultaneously sense Vector shift and a Rate Of Change Of Frequency (R.O.C.O.F) as measurement parameters in compliance with G.59/1 and ETR 13. For optimum safety each generator should have its own Vector Shift and ROCOF protection relay.

Description

The Vector Shift and ROCOF relays provide continuous simultaneous supervision of vector shift and rate of change of frequency functions. The relay monitors power quality and disconnections, allowing fast, reliable and accurate mains failure detection to protect the network, load and the generator. This highly innovative relay can additionally be used to measure the actual conditions at the generator site, thus facilitating the setting of the correct trip point, trip logging, and the provision of simple and reliable commissioning.

Vector Shift Relay

The Vector Shift relay measures the length of each cycle of the voltage wave. At the moment a genset becomes disconnected, the sudden change in load causes a sudden change in cycle length. The single cycle becomes shifted with time: it takes longer or shorter. The speed of sensing is fast enough to complete the opening of the genset main circuit breaker before the auto recloser completes reclosing. Hence the Vector Shift relay is an excellent method of detecting disconnection from the grid.

ROCOF Relay

The R.O.C.O.F. relay senses stability of the frequency. A genset in routine operation will have a normal frequency excursion due to changing loads and the compensated fuel inlet. These frequency excursions are small. The rate at which the frequency changes inside these excursions is relatively high compared with those of a large network. The speed of sensing is fast enough to complete the opening of the genset main circuit breaker before the auto reclosers complete reclosing. Hence a R.O.C.O.F. relay adjacent to the genset is also an excellent method of detecting disconnection from the grid.

Operation

Health Monitoring

The unit incorporates additional circuitry to continuously monitor its own operation. This is essential to maintain confidence in the protection system itself. It monitors conditions such as correct software execution, correct voltages within the hardware and functionality of the microprocessor core. If any faults are detected the unit will indicate an error condition and restart.

Dependability

The relay uses sophisticated change detection algorithms to avoid spurious trips. These can occur during normal grid switching. The Vector Shift algorithm includes a unique routine which analyses the cycles immediately before and after a possible event. This results in a response only to a true phase step or Vector Shift condition. To allow for a step change of up to 20% of rated load, a limit setting of 16 electrical degrees is typical. This can be reduced to 6 electrical degrees on low impedance networks, but is user selectable between 2 and 24 electrical degrees.

Features

Compliant with utility industry requirements

Unique algorithm

Continuous self supervision

Controlled power up/down

Status and fault indication

PC logging and indicating software

Digital data and status output

External input for "holding off"

Internal self check functions

Change over relay contacts

User selectable settings

Benefits

Fast, reliable and accurate mains failure detection

Power quality and disconnection monitoring

Protection of grid, load and generator

DIN rail or panel front mounted options

Vector shift and ROCOF functions housed in one unit

Improved discrimination

Nuisance tripping avoidance

Simple installation and operation

Applications

G.59/1 protection

Generator sets

Co-generation

Uninterruptible power supplies (UPS)

Base load

Peak lopping

Combined heat and power (CHP)

Utility power monitoring

Compliant With

G.59/1, ETR 113

EMC, LVD and safety standards



Dual Functionality

The unit performs two distinct operations from the same basic information. The zero crossover points of the voltage waveform are monitored to establish the running average system frequency. This information then forms a reference for the two monitored parameters:

- a) **Vector Shift:** This algorithm responds to a single cycle of incorrect duration, as caused by a Vector Shift, and will qualify this by monitoring the next cycle. If the Vector Shift is not qualified the "near trip" LED is illuminated and no further action is taken. The response time for this operation is typically 40 ms in a 50 Hz system.
- b) **Rate of Change of Frequency (R.O.C.O.F):** The second algorithm performs a continuous comparison of the instantaneous frequency and the running average system frequency. This equates to the rate at which the generator is changing speed.



Output Latching

The alarm signal from either of the algorithms will cause the trip relay contacts to close. Should the out of range conditions return to normal, the relay will remain in the alarm state until the unit is manually or remotely reset. The control system can therefore be configured to ensure that the normal synchronisation procedure is followed before the generator is reconnected.

ROC-SOFT Trip Logging and Indicating Software

ROC-SOFT software functions as a simple meter and logger, and is available free on request. It enables three functions:

1. It becomes an effective R.O.C.O.F. meter and Vector Shift meter.
2. It enables the setting of the trip point, justified by actual site measurements.
 - Running the generator (optionally with site load) whilst islanded, the R.O.C.O.F. value will be displayed. R.O.C.O.F. is caused by the generators own control dynamics and by the demands from load changes.
 - Running the generator (optionally with site load) during a disconnection from the grid at a trip setting of 2°, the Vector Shift value will be displayed on tripping. Vector Shift is caused by a change in current, which will also cause a R.O.C.O.F.

The values obtained by measurement form a justified basis for setting the trip levels.

3. It is a simple trip logger, as every trip is logged, date and time stamped, and nature of trip. The following values are displayed:
 - Vector Shift trip levels set
 - Vector Shift trip level actual measured on trip
 - R.O.C.O.F. trip level set
 - R.O.C.O.F. trip level actual measured on trip
 - R.O.C.O.F. level actual measured at present.

As the measurements are so much faster than is practical to display, the display is updated once per second with the value at that time. Full data is available from the opto data socket, please see the User Manual. To print a log, press Alt and Print Screen on the PC keyboard. Then in Word select the clipboard contents and print.

Optical to RS232 Serial Converter

The Vector Shift and R.O.C.O.F. relay can be used in conjunction with our optical to digital adaptor, which converts optical fibre to RS232 digital signal levels for use with a PC. Crompton offer a 25 way or 9 way D socket adaptor to suit the PC, and a polymer fibre-optic cable to ensure the avoidance of electrical interference.



Model 246



Model 256

Specification

Input Supply	110, 120, 220, 230, 240, 380, 400, 415V
Input Range	-50%, +50%
Frequency	40 to 70 Hz
Harmonics	The monitored waveform must be free from harmonic oscillations near the zero crossover points
Burden	Input: 0.1VA Auxiliary: 4VA
Voltage Withstand (overload)	+50% continuous
Output	Volt free relay contacts
Relays	1x status, 1x fault
Contacts	Single pole changeover
Rating	250V, 5A A.C., resistive
Operations	0.2 million
Baud Rates	9600, 8 bit data, 1 stop bit. No parity
Auxiliary Supply	110, 120, 220, 230, 240, 380, 400, 415V
Auxiliary Range	±20%
Setting Accuracy	Vector Shift better than 1° R.O.C.O.F 0.05 Hz/s
Response Time	Phase angle shift: up to 2 cycles +5ms relay time Frequency rate change: 3 to 32 cycles + 5ms relay time
Isolation	BS 142, Section 1.3
Delay Range	0.1s
Phase Angle Shift	0.5 degree at 50/60 Hz
Frequency Rate Change	0.1Hz/s
Vibration	BSEN60068-2-6
User Adjustments	Initial auxiliary supply switch-on delay: 1 to 10 seconds Phase Angle Shift Adjustment: 2 to 24° Frequency Rate Change Adjustment: 0.1 to 1Hz/s
Indication	Green LED indicates auxiliary power presence Yellow LED indicates near trip Red LED indicates Vector/ROCOF trip and relay energised
Enclosure Style	Model 246: Front of panel mounting Model 256: DIN rail mounting
Compliant With	EMC and LVD, G.59/1 & ETR 113, BSEN 61010-1993 AMD 8961 1996, BSEN 50081-1, BSEN 50082-2,
Material	Flame retardant UL94V0
Operating Temperature	0°C to 50°C normal -10°C to 50°C extended. Performance may not meet published specification but the unit will not sustain permanent damage in this range
Storage Temperature	-10°C to +70°C
Relative Humidity	<95% non condensing
Weight	Model 246: 1.1kg Model 256: 0.8kg
Model 246 Dimensions	147mm (5.8") high x 147mm (5.8") wide x 146mm (5.7") deep. Panel Cut Out: 138mm (5.4") x 138mm (5.4")
Model 256 Dimensions	70mm (2.8") high x 150mm (5.9") wide x 113mm (4.4") deep

Product Codes

Description	Inputs	Catalogue No.
Model 246 Panel Front Mount	230V, 40/70 Hz	246-ROCL-RQBX-C2-RQ
Model 246 Panel Front Mount	400V, 40/70 Hz	246-ROCL-SCBX-C2-RQ
Model 256 DIN Rail Mount	230V, 40/70 Hz	256-ROCL-RQBX-C2-RQ
Model 256 DIN Rail Mount	400V, 40/70 Hz	256-ROCL-SCBX-C2-RQ
PC Trip Logging and Indicating Software		ROC-SOFT
25D Optical to Digital Adaptor		25D-ODA
9D Optical to Digital RS232 Adaptor		9D-ODA
20 Meter Coil Polymer Fibre Optic Cable		O-A359



Model 246

Dimensions

Model 246

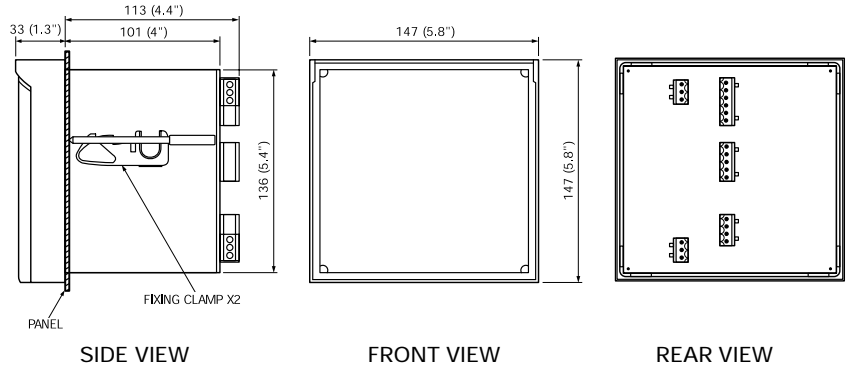

Model 256

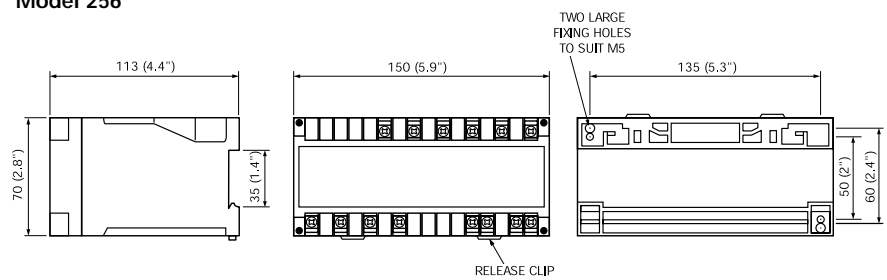

Model 256

Connections

Terminals 11 & 14 close on trip.
Terminals 21 & 24 close when the signal is monitored. (Self test O.K. LED lit)

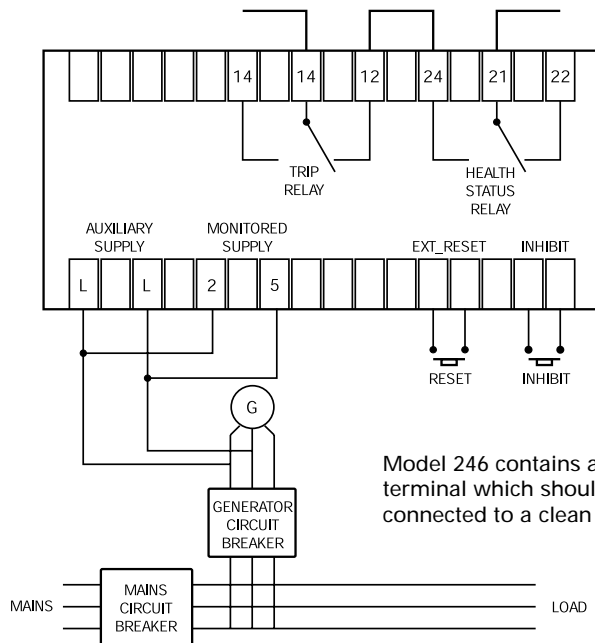

Model 246 contains an Earth terminal which should be connected to a clean earth.



A.C. Current Protector Relays

262 series A.C. current protector relays provide continuous surveillance. When the current value moves outside the zone limit, the relay operates giving double pole change-over contacts for alarm, control or tripping functions. The unit can be used to protect against over current or under current conditions for load detection, monitoring of electric heating systems, motors etc. For 3 phase systems, the sequence of connection is not important: simply connect each phase (C.T. secondary) to any pair of terminals marked. An illuminated red LED indicates when the relay is energised.

Features

- Alarm, control or tripping functions
- Protection against over or under current
- Load detection and monitoring
- LED indication of relay and auxiliary power status
- User accessible reset button option
- User selectable setpoint adjustment with optional tamper proof cover
- 5A two pole change over relay

Benefits

- 20 second time delay option
- Latching option available
- Energise/de-energise function options
- Nuisance tripping avoidance
- Simple installation and operation

Applications

- Switchgear
- Distribution systems
- Generator sets
- Control panels
- Process control
- Motor protection
- Transformers
- Overload protection

Compliant With

EMC, LVD, BS5458, BSEN61010

Specification

Nominal Input Current	1A, 5A or 10A
System Frequency	50, 60 or 400Hz
Input Current Burden	0.5VA per phase
Overloads	2 x rating continuously, 10 x rating for 3 seconds
Set Point Repeatability	0.5% of full span
Differential (Hysteresis)	Preset at 1%. Values 1% to 10% available on request
Trip Level	Adjustable 40 to 120% for over and under current models
Operating Delay	Adjustable 0 to 10 seconds
Auxiliary Supply Voltage	120V, 230V, 240V, 400V or 415V ±20%
Auxiliary Supply Frequency	50, 60, 50/60 or 400Hz
Auxiliary Voltage Burden	4VA (max)
Relay Contact Rating	5A 240V, non inductive
Relay Mechanical Life	0.2 million operations
Operating Temperature	0°C to +60°C
Storage Temperature	-20°C to + 70°C
Compliant With	EMC, LVD, BS5458, BSEN61010
Dimensions	48mm (1.9") wide x 96mm (3.8") high x 142mm (5.6") deep (max)
Panel Cut Out	45mm (1.8") wide x 92mm (3.6") high

Product Codes

Relay	Protection	ANSI No.	Catalogue No.
Single phase	Under current 40-120%	37	262-PAU
Single phase	Over current 40-120%	51	262-PAO
3 phase 3/4 wire	Under current 40-120%	37	262-PAV
3 phase 3/4 wire	Over current 40-120%	51	262-PAP

Please specify input current, frequency and auxiliary voltage at time of ordering.

Connections

262-PAU
262-PAO

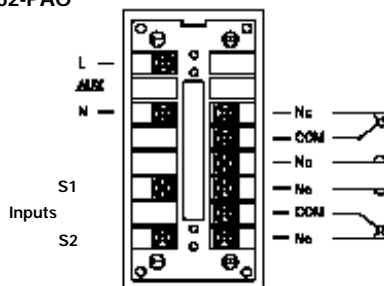

262-PAP
262-PAV

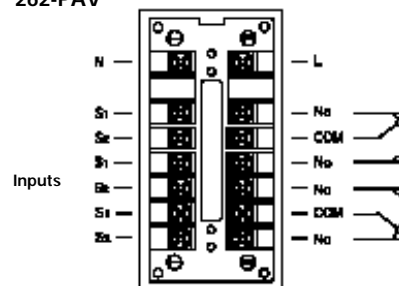



A.C. Voltage Protector Relays

The 262 series A.C. voltage protectors provide continuous surveillance of the monitored circuit. When the measured voltage moves outside the setpoint limit, the relay will operate giving an alarm or initiation signal. The protector can be used to protect against under or over voltage, to start up stand-by generators, to operate mains failure units, for switching standby hybrid supplies, protecting computer supplies and similar applications where close regulation is required. The 3 phase, 3 or 4 wire models, monitors all of the phases. An illuminated red LED indicates when the relay is energised.

Specification

Nominal System Voltage	Single Phase: 120V or 230V 3 phase: 120, 208 or 400V
System Frequency	50, 60 or 400Hz
Voltage Withstand (overload)	1.2 x continuously. 1.5 x for 10 x 10 seconds to BS 6253
Set Point Repeatability	> 0.5%
Differential (Hysteresis)	Over voltage models: Adjustable 0 to 15% above nominal Under voltage models: Adjustable 0 to 15% below nominal
Trip Level	Adjustable 75 - 100% for under voltage models Adjustable 100 -125% for over voltage models
Operating Delay	Typically 250ms. Internal factory fixed delay up to 20 seconds
Voltage Burden	3VA
Relay Contact Rating	5A 240V, non inductive
Relay Mechanical Life	0.2 million operations
Operating Temperature	0°C to +60°C
Storage Temperature	-20°C to + 70°C
Compliant With	EMC, LVD, BS5458, BSEN61010
Dimensions	48mm (1.9") wide x 96mm (3.8") high x 142mm (5.6") deep (max)
Panel Cut Out	45mm (1.8") wide x 92mm (3.6") high

Features

- Alarm, control or tripping functions
- Protection against under and over voltage
- LED indication of relay and auxiliary power status
- User accessible reset button option
- User selectable setpoint adjustment with optional tamper proof cover
- 5A two pole change over relay

Benefits

- 20 second time delay option
- Latching option available
- Energise/de-energise function options
- Nuisance tripping avoidance
- Simple installation and operation
- Start up of standby generators
- Operation of mains failure units
- Switching of standby hybrid supplies

Applications

- Switchgear
- Distribution systems
- Generator sets
- Control panels
- Process control
- Motor protection
- Transformers
- Overload protection

Compliant With

EMC, LVD, BS5458, BSEN61010

Product Codes

Relay	Protection	ANSI No.	Catalogue No.
Single phase	Under voltage 75-100%	27	262-PVU
Single phase	Over voltage 100-125%	59	262-PVO
3 phase 3 wire	Under voltage 75-100%	27	262-PVK
3 phase 3 wire	Over voltage 100-125%	59	262-PVA
3 phase 4 wire	Under voltage 75-100%	27	262-PVV
3 phase 4 wire	Over voltage 100-125%	59	262-PVP

Specify system voltage and frequency at time of ordering.

Connections

262-PVU
262-PVO

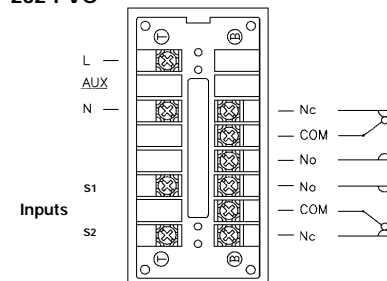

262-PVA
262-PVK
262-PVP
262-PVV

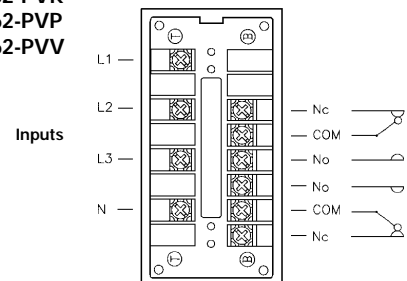



Frequency Protector Relays

The 262 series frequency protector relays will operate giving an alarm, control or tripping signal when the frequency moves outside the setpoint limit. Since the speed of a genset determines the A.C. power frequency this unit can be used to protect A.C. generator plant against overspeed or underspeed. Typical applications include diesel-generator sets, standby supplies for industrial, hospital or marine use, mains supplies, computer supplies and other control gear. An illuminated red LED indicates when the relay is energised.

Features

- Alarm, control or tripping functions
- Protection against over or under speed
- LED indication of relay and auxiliary power status
- User accessible reset button option
- User selectable setpoint adjustment with optional tamper proof cover
- 5A two pole change over relay

Benefits

- 20 second time delay option
- Latching option available
- Energise/de-energise function options
- Nuisance tripping avoidance
- Simple installation and operation

Applications

- Switchgear
- Distribution systems
- Generator sets
- Control panels
- Process control
- Motor protection
- Marine panels
- Transformers
- Overload protection
- Standby supplies

Compliant With

EMC, LVD, BS5458, BSEN61010

Specification

Nominal Frequency	50, 60 or 400Hz
System Voltage	120V, 230V, 240V, 400V or 415V ±20%
Voltage Withstand (overload)	1.2 x continuously. 1.5 x for 10 x 10 seconds to BS 6253
Set Point Repeatability	> 0.5%
Trip Level	Adjustable 40 to 60Hz, 50 to 70Hz and 360 to 440Hz
Differential (Hysteresis)	0.1 to 3.0Hz adjustable on 40 to 70 Hz models or 10 to 30Hz adjustable on 400Hz models
Voltage Burden	3VA
Relay Contact Rating	5A 240V, non inductive
Relay Mechanical Life	0.2 million operations
Operating Delay	Typically 250ms. Internal factory fixed delay up to 20 seconds
Operating Temperature	0°C to +60°C
Storage Temperature	-20°C to + 70°C
Compliant With	EMC, LVD, BS5458, BSEN61010
Dimensions	48mm (1.9") wide x 96mm (3.8") high x 142mm (5.6") deep (max)
Panel Cut Out	45mm (1.8") wide x 92mm (3.6") high

Product Codes

Relay	Protection	ANSI No.	Catalogue No.
Single phase	Under frequency	81U	262-PHU
Single phase	Over frequency	81O	262-PHO

Specify system voltage and frequency at time of ordering.

Dimensions

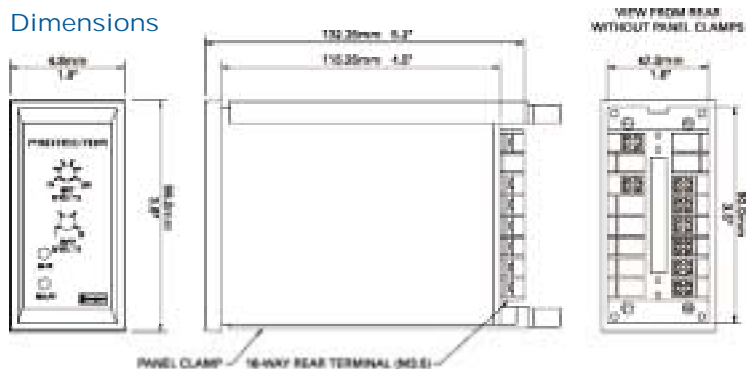

Connections

262-PHU
262-PHO

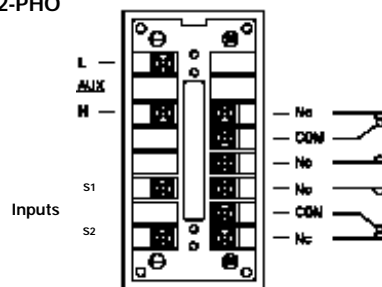

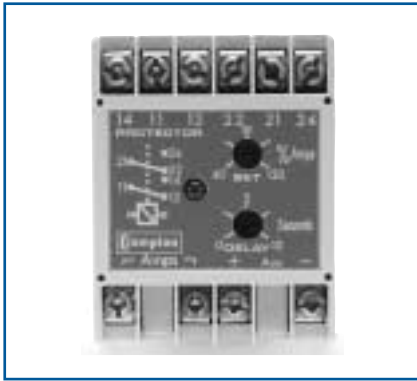

A.C. Current with Adjustable Time Delay

250 series A.C. current protectors provide continuous surveillance of the monitored circuit. When the current moves outside the setpoint limit, the relay operates. The protector can be used to monitor over and under current conditions, load detection, and for monitoring electric heating systems. An illuminated LED indicates when the relay is energised. For 3 phase systems, the sequence of connection is not important.

Operation

A.C. current protectors provide continuous surveillance of the monitored circuit. These products offer user adjustable trip point (setpoint) and time delay settings. The setpoint adjustment range is between 40% and 120% of the nominal current. Input currents can be via current transformers or direct up to 10A. An internal differential setting of 1% reduces nuisance tripping if the measured signal is noisy or unstable. When the measured current moves outside the setpoint limit, the relay will operate, giving an alarm or initiation signal. An adjustable time delay is provided to prevent the relay from tripping for a predetermined period to prevent nuisance tripping. The units draw their operating power from a separate auxiliary supply input. Single phase and three phase products are available. Three phase products monitor the current level for each phase, and are not phase sequence sensitive. Combined units offer under and over current trips in one compact unit. Single function units are also available.

Over Current Models

When the monitored current exceeds the setpoint, the relay will energise and the red LED will illuminate to indicate the trip condition. The relay will automatically reset once the monitored current falls below the setpoint minus the differential. When reset, the LED will extinguish and the relay de-energises.

Under Current Models

When the monitored current falls below the setpoint, the relay will de-energise and the red LED will extinguish to indicate the trip condition. The relay will automatically reset once the monitored current rises above the setpoint plus the differential. When reset, the LED will illuminate and the relay energises.

Options

250 series protector relays offer various customised options to suit individual requirements. Please consult factory.

- Adjustment ranges - different adjustment ranges are possible for the setpoint and differential controls.
- Relay operation - standard models are fail safe, but the relays can be customised to energise or de-energise on trip.

Product Codes

Relay	Protection	ANSI No.	Catalogue No.
Single phase	Under current 40-120%	37	252-PAU
Single phase	Over current 40-120%	51	252-PAO
Single phase	Under and over current	37/51	253-PAD
3 phase 3 or 4 wire	Under current 40-120%	37	253-PAV
3 phase 3 or 4 wire	Over current 40-120%	51	253-PAP

Specify system voltage, system current, frequency and required options at time of ordering.

Features

- Single and 3 phase options
- Adjustable setpoint
- Adjustable time delay
- Internal differential
- LED trip indication
- Double pole relay contacts
- Automatic reset

Benefits

- Ideal for any electrical load detection
- Over and under current monitoring
- Suitable for electric heating systems
- Ensures load current is within generator capacity
- Detects broken drive belts on machinery
- Nuisance tripping avoidance
- Customised options

Applications

- Marine panels
- Switchgear
- Distribution systems
- Generator sets
- Control panels
- Process control
- Motor protection
- Transformers
- Overload protection

Approvals

- UL, CSA, BV and ABS

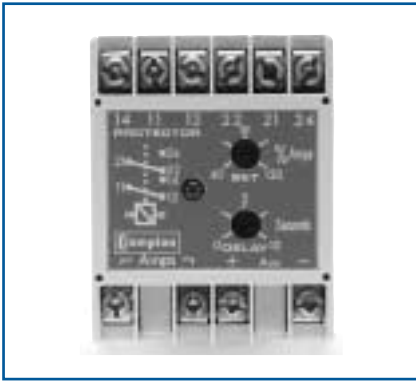

Specification – AC Current with Adjustable Time Delay

Nominal Input Current	1A or 5A from CT secondary. 0.2A to 10A available on request
Nominal Frequency	50, 60 or 400Hz
Input Current Burden	0.5VA per phase
Overload	2 x rating continuously, 10 x rating for 3 seconds
Set Point Repeatability	>0.5% of full span
Differential (Hysteresis)	Preset at 1%. Values 1% to 10% available on request
Trip Level Adjustment	40 to 120%. Customised adjustment available
Time Delay Adjustable	0 to 10 seconds
AC Auxiliary Supply Voltage	100V, 110V, 120V, 208V, 220V, 240V, 480V, ±20%
DC Auxiliary Supply Voltage	12V, 24V, 48V, 110V or 125V, ±15%. Max ripple 15%
Auxiliary Voltage Burden	4VA (max)
Output Relay	Double pole change over
Relay Contact Rating	AC: 240V 5A, non inductive DC: 24V, 5A resistive
Relay Mechanical Life	0.2 million operations at rated loads
Relay Reset	Automatic
Operating Temperature	0°C to +60°C (0°C to +40°C for UL models)
Storage Temperature	-20°C to +70°C
Temperature Co-efficient	0.05% per °C
Interference Immunity	Electrical stress surge withstand and non-function to ANSI/IEEE C37 90a
Enclosure Style	DIN rail with wall mounting facility
Material	Flame retardant polycarbonate/ABS
Enclosure Integrity	IP50
Compliant With	EMC, LVD, Safety Standard IEC 414 UL File No: E113067 recognised up to 600V CSA File No: LR52592 up to 300V BV File No: 2650H-07427-AO-PRSO BV ABS File No: 93-LD 17806-X
Model 252 Dimensions	55mm (2.2") wide x 70mm (2.8") high x 112mm (4.4") deep
Model 253 Dimensions	75mm (2.9") wide x 70mm (2.8") high x 112mm (4.4") deep
Weight	Model 252: 0.4Kg approx. Model 253: 0.6Kg approx.

Connections

252-PAU
252-PAO

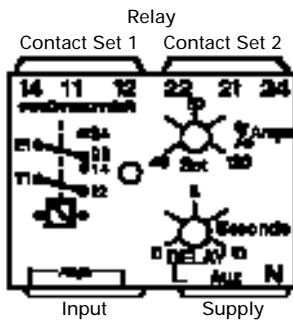

253-PAD

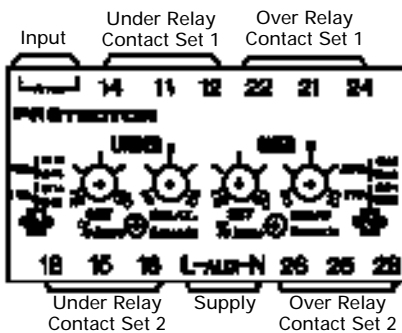

253-PAP
253-PAV

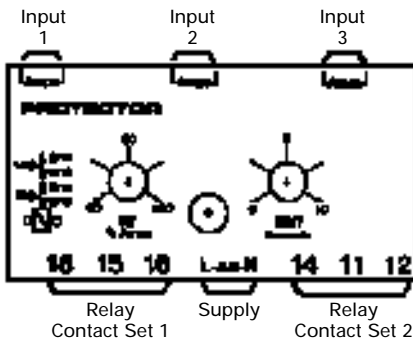

Dimensions

Model 252

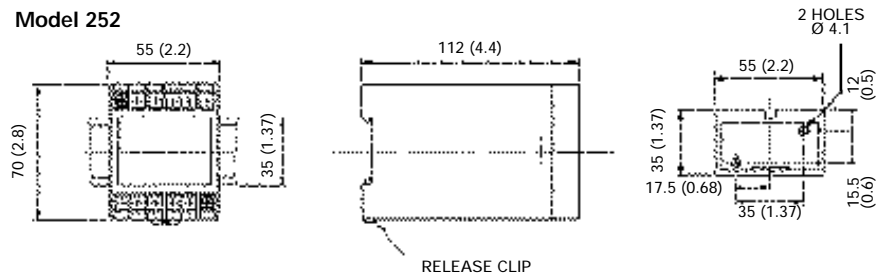

Model 253

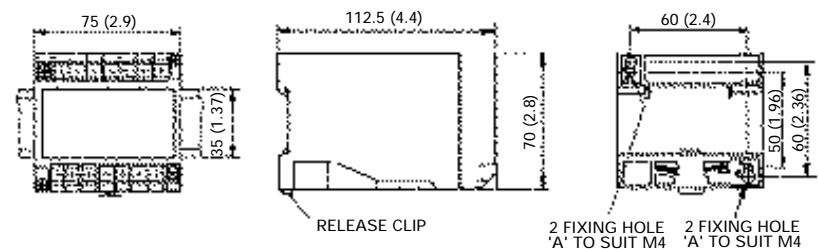

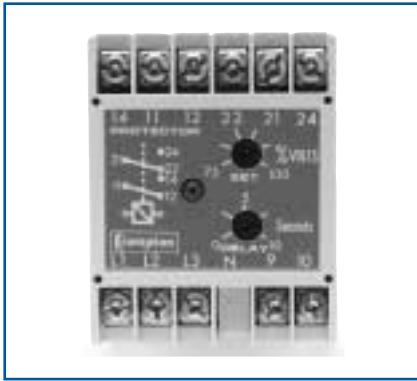

A.C. Voltage with Adjustable Time Delay

The A.C. voltage protectors provide continuous surveillance of the monitored circuit. When the measured voltage moves outside the setpoint limit, the relay will operate after the selected time delay, giving an alarm or initiation signal. Relays normally energise on overvolts and de-energise on undervolts. An illuminated LED indicates when the relay is energised.

Operation

A.C. voltage protectors offer user adjustable trip point (setpoint) and time delay settings. The setpoint adjustment range is 25%, operating between 75% and 100% of the nominal supply for under voltage units, and between 100% and 125% for the over voltage units. The time delay setting adjustment range is typically 0 to 10 seconds, although longer delays are available. As soon as the monitored signal moves outside of the setpoint limit, the time delay is activated, after which a trip will occur. The time delay prevents the relay from tripping for a predetermined period to prevent nuisance tripping.

The products also feature an internal differential (hysteresis) setting of 1% to reduce nuisance tripping if the measured signal is noisy or unstable. The units draw their operating power from the measuring inputs, although a separate auxiliary supply input option is available on some models. Single phase and three phase products are available, three phase products monitor the voltage level for each phase, and are not phase sequence sensitive.

Over Voltage Models

When the monitored voltage exceeds the setpoint, the time delay is started. When the time has elapsed, the relay will energise and the red LED will illuminate to indicate the trip condition. The relay will automatically reset once the monitored voltage falls below the setpoint minus the differential. When reset, the LED will extinguish and the relay de-energises. The time delay is not active when resetting.

Under Voltage Models

When the monitored voltage falls below the setpoint, the time delay is started. When the time has elapsed, the relay will de-energise and the red LED will extinguish to indicate the trip condition. The relay will automatically reset once the monitored voltage rises above the setpoint plus the differential. When reset, the LED will illuminate and the relay energises. The time delay is not active when resetting.

Options

250 series protector relays offer various customised options to suit individual requirements.

Please consult factory.

- Adjustment ranges - different adjustment ranges are possible for the setpoint and differential controls.
- Separate auxiliary supply - sometimes required to maintain a time delay or energised relay when the monitored signal fails.
- Differential - internally fixed value between 1% and 15%.
- Relay operation - standard models are fail safe, but the relays can be customised to energise or de-energise on trip.

Product Codes

Relay	Protection	ANSI No.	Catalogue No.
Single phase	Under voltage 75-100%	27	252-PVZ
Single phase	Over voltage 100-125%	59	252-PVH
3 phase 3 wire	Under voltage 75-100%	27	252-PVJ
3 phase 3 wire	Over voltage 100-125%	59	252-PVC
3 phase 4 wire	Under voltage 75-100%	27	252-PVX
3 phase 4 wire	Over voltage 100-125%	59	252-PVS

Specify system voltage, frequency and required options at time of ordering.

Features

- Adjustable setpoint
- Adjustable time delay
- Internal differential
- LED trip indication
- Double pole relay contacts
- Automatic reset

Benefits

- Over and under voltage monitoring
- Close voltage control
- Start standby generators
- Operation of mains failure units
- Switching standby supplies
- Protecting computer supplies
- Monitors genset AVR and excitation systems
- Nuisance tripping avoidance
- Customised options

Applications

- Switchgear
- Distribution systems
- Generator sets
- Control panels
- Process control
- Motor protection
- Transformers
- Overload protection

Approvals

- UL and CSA

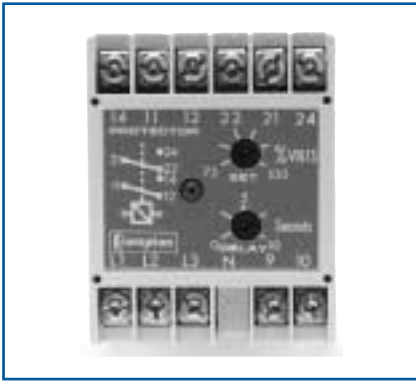

Specification – AC Voltage with Adjustable Time Delay

Nominal Voltage	100V, 110V, 208V, 240V, 277V, 400V, 415V, 440V or 480V
System Frequency	45/65Hz or 360/440Hz
Voltage Burden	0.3VA
Overload	1.2 x rating continuously, 1.5 x rating for 10 x seconds
Set Point Repeatability	> 0.5% of full span
Differential (Hysteresis)	Preset at 1%. Other values 1% to 10% to order
Trip Level Adjustment	Under Voltage: 75 to 100% Over Voltage: 100 to 125% of nominal input voltage
Time Delay	Adjustable up to 10 seconds
AC Auxiliary Supply Voltage	100V, 110V, 120V, 208V, 220V, 240V, 480V, ±20%
DC Auxiliary Supply Voltage	12V, 24V, 48V, 110V or 125V, ±15%. Max ripple 15%
Auxiliary Voltage Burden	4VA (max)
Output Relay	Double pole change over
Relay Contact Rating	AC: 240V 5A, non inductive DC: 24V, 5A resistive
Relay Mechanical Life	0.2 million operations at rated loads
Relay Reset	Automatic
Operating Temperature	0°C to +60°C (0°C to +40°C for UL models)
Storage Temperature	-20°C to + 70°C
Temperature Co-efficient	0.05% per °C
Interference Immunity	Electrical stress surge withstand and non-function to ANSI/IEEE C37 90a
Enclosure Style	DIN rail with wall mounting facility
Material	Flame retardant polycarbonate/ABS
Enclosure Integrity	IP50
Compliant With	EMC, LVD, Safety Standard IEC 414 UL File No: E113067 recognised up to 600V CSA File No: LR52592 up to 300V
Dimensions	55mm (2.2") wide x 70mm (2.8") high x 112mm (4.4") deep
Weight	0.4Kg approx.

Connections

252-PVZ
252-PVH

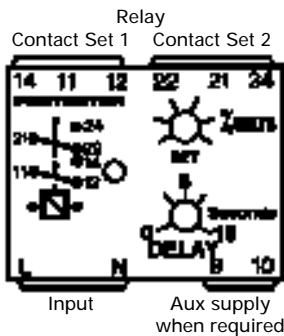

252-PVX
252-PVS
252-PVC
252-PVJ

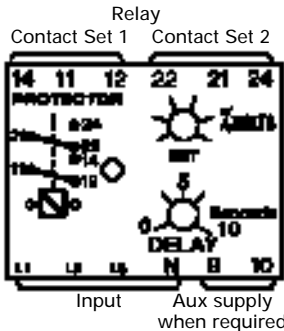

Note: The neutral connection is always used on 4 wire systems.

Dimensions

Model 252

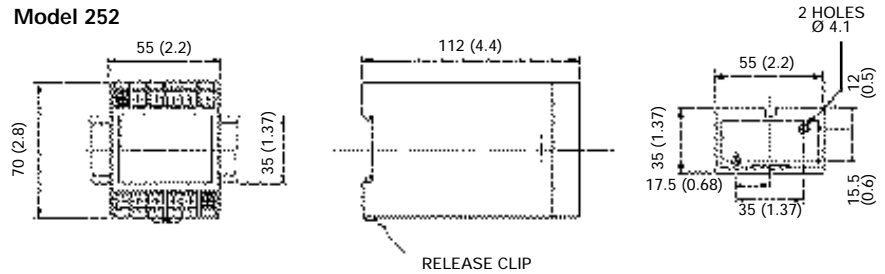

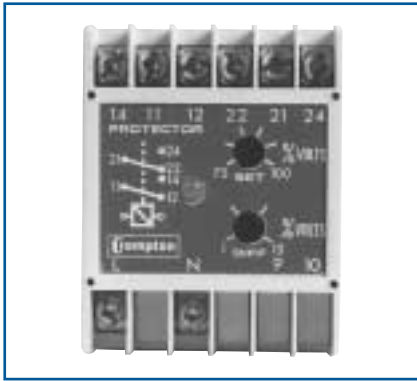

A.C. Voltage with Adjustable Differential

The A.C. voltage protectors provide continuous surveillance of the monitored circuit. When the measured voltage moves outside the setpoint limit, the relay will operate giving an alarm or initiation signal. The protector can be used for under and over voltage detection, start standby generators, operation of mains failure units, and switching standby supplies. An illuminated LED indicates when the relay is energised. The 3 phase, 3 or 4 wire models, protect each phase independently.

Operation

A.C. voltage protectors offer user adjustable trip point (setpoint) and differential (hysteresis) settings. The setpoint adjustment range is 25%, operating between 75% and 100% of the nominal supply for under voltage units, and between 100% and 125% for the over voltage units. The differential setting adjustment range is 1% to 15%, and it can be used to reduce nuisance tripping if the measured signal is noisy or unstable. When the measured voltage moves outside the setpoint limit, the relay will operate, giving an alarm or initiation signal.

As soon as the monitored signal moves outside of the setpoint limit, a trip will occur. A fixed time delay is available as a factory option, preventing the relay from tripping for a predetermined period to prevent nuisance tripping. The units draw their operating power from the measuring inputs, although a separate auxiliary supply input option is available on some models. Three phase products monitor the voltage level for each phase, and are not phase sequence sensitive. Combined units offer under and over voltage trips in one compact unit. Single function units are also available.

Over Voltage Models

When the monitored voltage exceeds the setpoint, the relay will energise and the red LED will illuminate to indicate the trip condition. The relay will automatically reset once the monitored voltage falls below the setpoint minus the differential. When reset, the LED will extinguish and the relay de-energises.

Under Voltage Models

When the monitored voltage falls below the setpoint, the relay will de-energise and the red LED will extinguish to indicate the trip condition. The relay will automatically reset once the monitored voltage rises above the setpoint plus the differential. When reset, the LED will illuminate and the relay energises.

Options

250 series protector relays offer various customised options to suit individual requirements. Please consult factory.

- Time delay - internal fixed time delay before a trip occurs.
- Separate auxiliary supply - sometimes required to maintain a time delay or energised relay when the monitored signal fails.
- Adjustment ranges - different adjustment ranges are possible for the setpoint and differential controls.
- Relay operation - standard models are fail safe, but the relays can be customised to energise or de-energise on trip.

Product Codes

Relay	Protection	ANSI No.	Catalogue No.
Single phase	Under voltage 75-100%	27	252-PVU
Single phase	Over voltage 100-125%	59	252-PVO
Single phase	Under and over voltage	27/59	253-PVB
3 phase 3 wire	Under voltage 75-100%	27	252-PVK
3 phase 3 wire	Over voltage 100-125%	59	252-PVA
3 phase 3 wire	Under and over voltage	27/59	253-PVM
3 phase 4 wire	Under voltage 75-100%	27	252-PVV
3 phase 4 wire	Over voltage 100-125%	59	252-PVP
3 phase 4 wire	Under and over voltage	27/59	253-PVE

Specify system voltage, frequency, and required options at time of ordering.

Features

- Single and 3 phase models
- Adjustable setpoint
- Adjustable differential
- Internal time delay
- LED trip indication
- Double pole relay contacts
- Automatic reset

Benefits

- Over and under voltage monitoring
- Start standby generators
- Operation of mains failure units
- Switching standby supplies
- Monitors genset AVR and excitation systems
- Nuisance tripping avoidance
- Customised options

Applications

- Marine panels
- Switchgear
- Distribution systems
- Generator sets
- Control panels
- Process control
- Motor protection
- Transformers
- Overload protection

Approvals

UL , CSA , BV and ABS

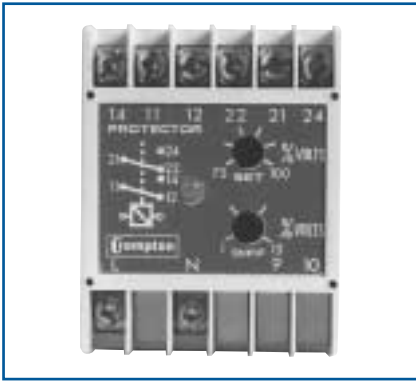

Specification – AC Voltage with Adjustable Differential

Nominal Voltage	100V, 110V, 120V, 208V, 220V, 270V, 280V, 400V, 415V or 440V
System Frequency	45/65Hz or 360/440Hz
Voltage Burden	0.3VA approx
Overload	1.2 x rating continuously, 1.5 x rating for 10 x seconds
Set Point Repeatability	>0.5% of full span
Differential (Hysteresis)	Adjustable range 1 to 15%
Trip Level Adjustment	Under Voltage: 75 to 100% Over Voltage: 100 to 125% of nominal input voltage
Time Delay	Factory preset up to 30 seconds
AC Auxiliary Supply Voltage	100V, 110V, 120V, 208V, 220V, 240V, 480V, ±20%
DC Auxiliary Supply Voltage	12V, 24V, 48V, 110V or 125V, ±15%. Max ripple 15%
Auxiliary Voltage Burden	4VA (max)
Output Relay	Double pole change over
Relay Contact Rating	AC: 240V 5A, non inductive DC: 24V, 5A resistive
Relay Mechanical Life	0.2 million operations at rated loads
Relay Reset	Automatic
Operating Temperature	0°C to +60°C (0°C to +40°C for UL models)
Storage Temperature	-20°C to + 70°C
Temperature Co-efficient	0.05% per °C
Interference Immunity	Electrical stress surge withstand and non-function to ANSI/IEEE C37 90a
Enclosure Style	DIN rail with wall mounting facility
Material	Flame retardant polycarbonate/ABS
Enclosure Integrity	IP50
Compliant With	EMC, LVD, Safety Standard IEC 414 UL File No: E113067 recognised up to 600V CSA File No: LR52592 up to 300V BV File No: 2650H-07427-AO PRSO BV (Model 253 only) ABS File No: 93-LD 17806-X (Model 253 only)
Model 252 Dimensions	55mm (2.2") wide x 70mm (2.8") high x 112mm (4.4") deep
Model 253 Dimensions	75mm (2.9") wide x 70mm (2.8") high x 112mm (4.4") deep
Weight	Model 252: 0.4Kg approx. Model 253: 0.6Kg approx

Connections

- 252-PVU
- 252-PVO
- 252-PVV
- 252-PVP
- 252-PVK
- 252-PVA

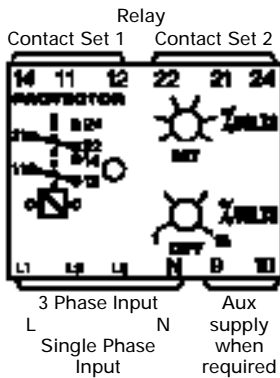

253-PVB

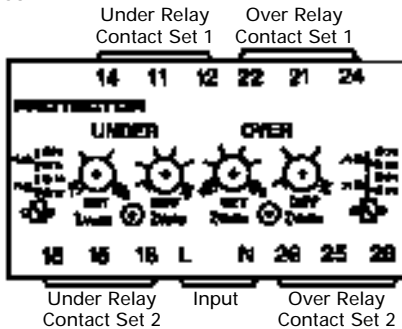

253-PVE 253-PVM

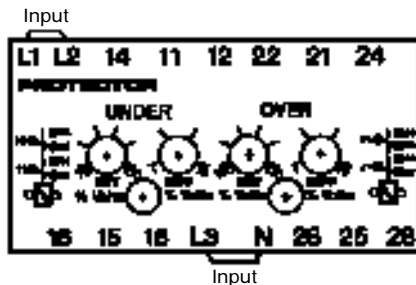

Note: The neutral connection is always used on 4 wire systems.

Dimensions

Model 252

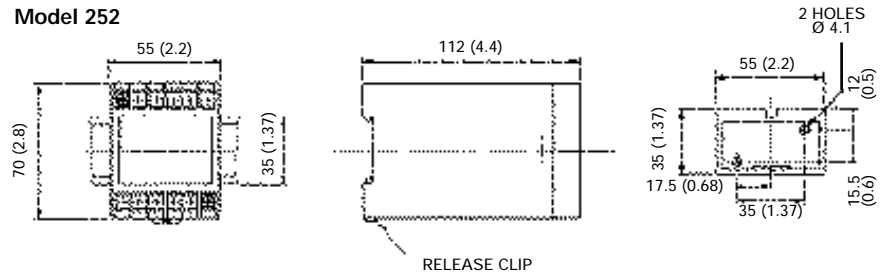

Model 253

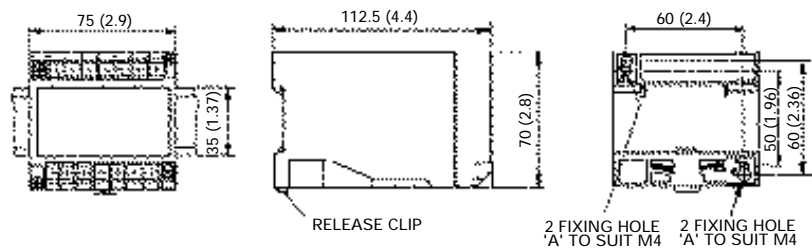

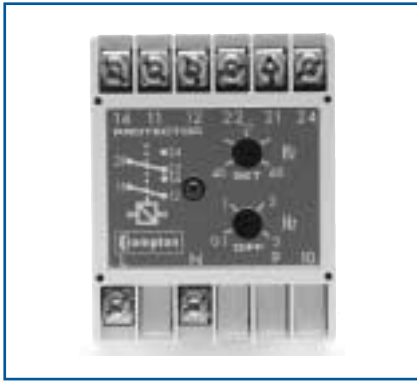

Frequency

Crompton frequency protectors give continuous surveillance of the monitored circuit. When the frequency moves outside the set point limit the relay will operate giving an alarm, control or tripping signal. An illuminated LED indicates when the relay is energised. Since speed is proportional to the frequency, this protector can be used to monitor over and underspeed, and to protect mains supplies, computer supplies, and standby supplies for Industrial, Hospital or Marine use.

Operation

Frequency protectors offer user adjustable frequency trip point (setpoint) and differential (hysteresis) settings. The setpoint adjustment range is centred around the nominal 50Hz, 60Hz or 400Hz system frequency. The differential setting adjustment can be used to reduce nuisance tripping if the measured signal is noisy or unstable. When the measured frequency moves outside the setpoint limit, the relay will operate, giving an alarm or initiation signal. As soon as the monitored frequency moves outside of the setpoint limit, a trip will occur. The units draw their operating power from the measuring inputs. Combined units offer under and over frequency trips in one compact unit. Single function units are also available.

Over Frequency Models

When the monitored frequency exceeds the setpoint, the relay will energise and the red LED will illuminate to indicate the trip condition. The relay will automatically reset once the monitored frequency falls below the setpoint minus the differential. When reset, the LED will extinguish and the relay de-energises.

Under Frequency Models

When the monitored frequency falls below the setpoint, the relay will de-energise and the red LED will extinguish to indicate the trip condition. The relay will automatically reset once the monitored frequency rises above the setpoint plus the differential. When reset, the LED will illuminate and the relay energises.

Options

250 series protector relays offer various customised options to suit individual requirements. Please consult factory.

- Adjustment ranges - different adjustment ranges are possible for the setpoint and differential controls.
- Time delay - internal fixed time delay before a trip occurs.
- Relay operation - standard models are fail safe, but the relays can be customised to energise or de-energise on trip.

Product Codes

Relay	Protection	ANSI No.	Catalogue No.
Single phase	Under frequency	81U	252-PHU
Single phase	Over frequency	81O	252-PHO
Single phase	Under and over frequency	81O/U	253-PHD

Specify system voltage, frequency and required options at time of ordering.

Features

- Adjustable setpoint
- Adjustable differential
- LED trip indication
- Double pole relay contacts
- Automatic reset

Benefits

- Over and under frequency monitoring
- Over and underspeed monitoring
- Start standby generators
- Operation of mains failure units
- Switching standby supplies
- Protection of control gear
- Nuisance tripping avoidance
- Customised options

Applications

- Marine panels
- Switchgear
- Distribution systems
- Generator sets
- Control panels
- Process control
- Motor protection
- Transformers
- Overload protection

Approvals

- UL, CSA, BV and ABS

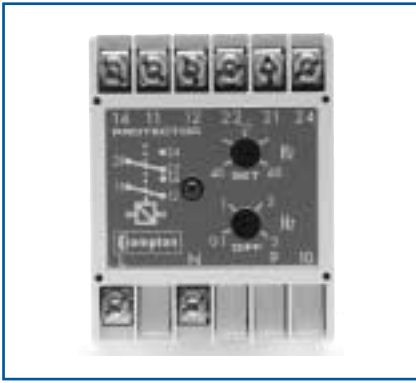

Specification – Frequency

Nominal Voltage	100V, 110V, 120V, 208V, 220V, 230V, 240V, 277V, 380V, 400V, 415V, 440V or 480V ± 20%
System Frequency	40/60Hz, 50/70Hz or 360/440Hz
Voltage Burden	3VA
Overloads	1.2 x rating continuously, 1.5 x rating for 10 x seconds
Set Point Repeatability	>0.5% of full span
Differential (Hysteresis)	40/60Hz, 50/70Hz: Adjustable 0.1 to 3.0Hz 360/440Hz: Adjustable 10 to 30Hz
Output Relay	Double pole change over
Relay Contact Rating	AC: 240V 5A, non inductive DC: 24V, 5A resistive
Relay Mechanical Life	0.2 million operations at rated loads
Relay Reset	Automatic
Operating Temperature	0°C to +60°C (0°C to +40°C for UL models)
Storage Temperature	-20°C to + 70°C
Temperature Co-efficient	0.05% per °C
Interference Immunity	Electrical stress surge withstand and non-function to ANSI/IEEE C37 90a
Enclosure Style	DIN rail with wall mounting facility
Material	Flame retardant polycarbonate/ABS
Enclosure Integrity	IP50
Compliant With	EMC, LVD, Safety Standard IEC 414 UL File No: E113067 recognised up to 600V CSA File No: LR52592 up to 400Hz 300V BV File No: 2650H-07427-AO PRSO BV ABS File No: 93-LD 17806-X
Model 252 Dimensions	55mm (2.2") wide x 70mm (2.8") high x 112mm (4.4") deep
Model 253 Dimensions	75mm (2.9") wide x 70mm (2.8") high x 112mm (4.4") deep
Weight	Model 252: 0.4Kg approx. Model 253: 0.6Kg approx

Connections

252-PHU
252-PHO

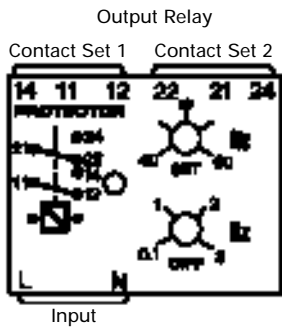

253-PHD

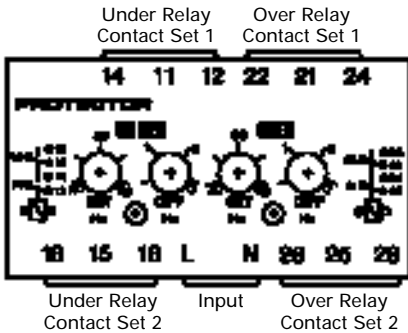

Dimensions

Model 252

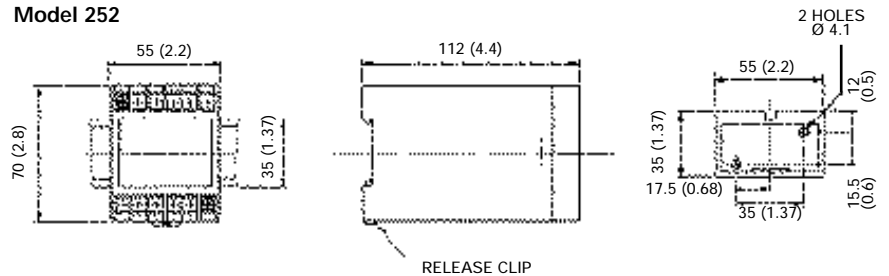

Model 253

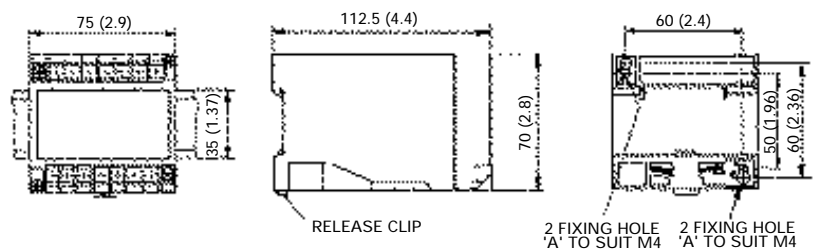

Ziegler

Redefine Innovative Metering

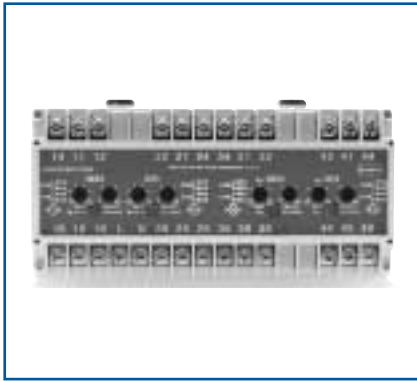

Combined Under/Over Voltage and Frequency

The 250 series combined voltage & frequency protectors provide continuous surveillance of the monitored circuit. When the voltage or frequency moves outside the set point limit the respective relay will operate giving an alarm, control or tripping signal. An illuminated LED indicates when the relay is energised. This protector can be used to protect against over and underspeed and over and under voltage.

Operation

Combined voltage and frequency protectors provide the most popular relay functions in one convenient package. The products offer user adjustable trip point (setpoint) for voltage and frequency, plus adjustable time delay settings. The setpoint adjustment range is 25%, operating between 75% and 100% of the nominal supply for under voltage, and between 100% and 125% for over voltage. The frequency setpoint adjustment range is centred around the nominal 50Hz, 60Hz or 400Hz system frequency. The time delay setting adjustment range is typically 0 to 10 seconds, although longer delays are available.

As soon as the monitored signal moves outside of the setpoint limit, the time delay is activated, after which a trip will occur. The time delay prevents the relay from tripping for predetermined period to prevent nuisance tripping. The products also feature an internal differential (hysteresis) setting of 1% to reduce nuisance tripping if the measured signal is noisy or unstable. The product is available for single phase systems only, and draws its operating power from the measuring input.

Over Voltage and Frequency

When the monitored value exceeds the setpoint and the time delay has elapsed, the relay will energise and the red LED will illuminate to indicate the trip condition.

Under Voltage and Frequency

The relay will de-energise after the time delay has elapsed, and the red LED will extinguish to indicate the trip condition.

Options

250 series protector relays offer various customised options to suit individual requirements. Please consult factory.

- Adjustment ranges - different adjustment ranges are possible for the setpoint and time delay controls.
- Differential - internally fixed value between 1% and 15%.
- Relay operation - standard models are fail safe, but the relays can be customised to energise or de-energise on trip.

Product Codes

Relay	Protection	ANSI No.	Catalogue No.
Single phase	Over and under voltage, over and under frequency	27/59, 81O/U	256-PHV

Specify system voltage, frequency and required options at time of ordering.

Features

- Adjustable setpoint
- Adjustable time delay
- Internal differential
- LED trip indication
- Double pole relay contacts
- Automatic reset

Benefits

- Over and under voltage monitoring
- Over and underspeed monitoring
- Start standby generators
- Operation of mains failure units
- Switching standby supplies
- Monitors genset AVR and excitation systems
- Nuisance tripping avoidance
- Customised options

Applications

- Switchgear
- Distribution systems
- Generator sets
- Control panels
- Process control
- Motor protection
- Transformers
- Overload protection

Approvals

- UL recognised

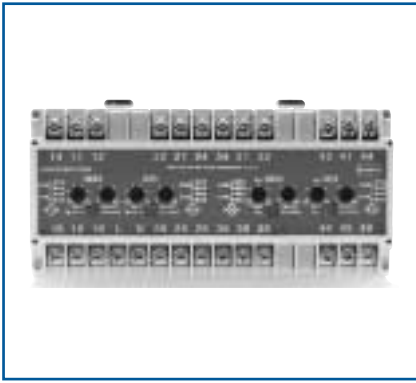

Dimensions

Model 256

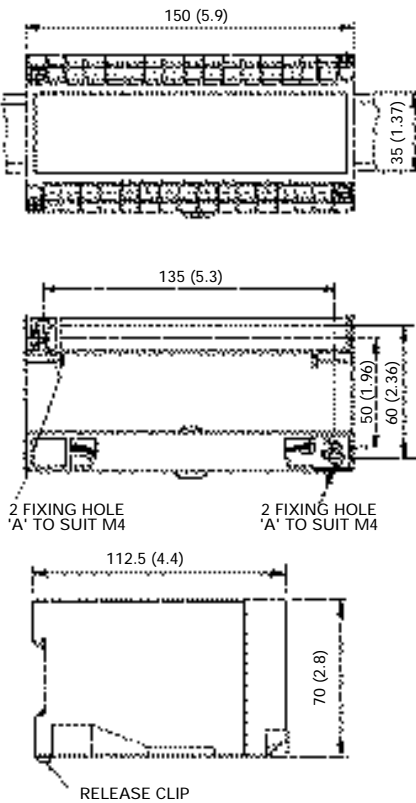

Specification – Combined Under/Over and Frequency

Nominal Voltage	100V, 110V, 120V, 208V, 220V, 270V, 280V, 400V, 415V or 440V
System Frequency	40/60Hz, 50/70Hz or 360/440Hz
Frequency Differential	Preset at 0.1Hz (10Hz for 400Hz unit)
Voltage Burden	3VA
Overloads	1.2 x rating continuously, 1.5 x rating for 10 x seconds
Set Point Repeatability	>0.5% of full span
Differential (Hysteresis)	Fixed internally at 1%
Trip Level Adjustment	Over voltage: 100 to 125% Under Voltage: 75 to 100% of nominal input voltage
Time Delay	Adjustable 1 to 30 seconds
Output Relay	4 independent double pole change over
Relay Contact Rating	AC: 240V 5A, non inductive DC: 24V, 5A resistive
Relay Mechanical Life	0.2 million operations at rated loads
Relay Reset	Automatic
Operating Temperature	0°C to +60°C (0°C to +40°C for UL models)
Storage Temperature	-20°C to + 70°C
Temperature Co-efficient	0.05% per °C
Interference Immunity	Electrical stress surge withstand and non-function to ANSI/IEEE C37 90a
Enclosure Style	DIN rail with wall mounting facility
Material	Flame retardant polycarbonate/ABS
Enclosure Integrity	IP50
Compliant With	EMC, LVD, Safety Standard IEC 414 UL File No: E113067 recognised up to 600V
Dimensions	150mm (5.9") wide x 70mm (2.8") high x 112mm (4.4") deep
Weight	1.0Kg approx

Connections

256-PHV

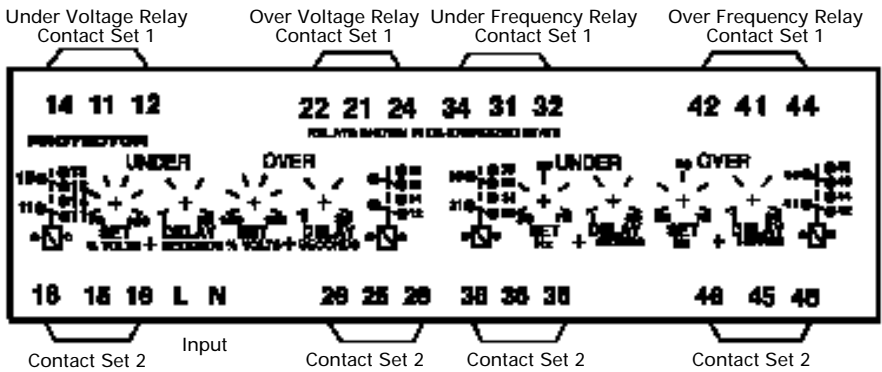

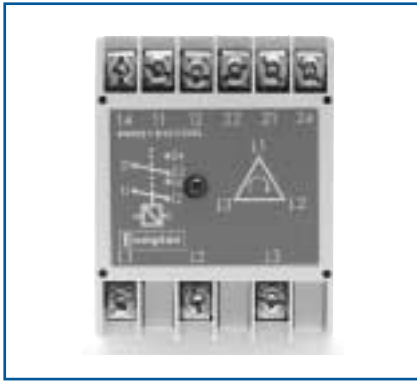

Phase Sequence and Phase Failure

The Crompton phase sequence and phase failure protector relays are designed to monitor the correct phase rotation or sequence of three phase, 3 or 4 wire supply systems and provide protection against incorrect phase sequence, loss of one phase, and under voltage.

Operation

Rotating machines are particularly vulnerable to incorrect phase sequence. Three phase motors can rotate in the wrong direction, potentially leading to physical damage or the risk of injury to personnel, yet voltage and current readings may appear normal. If one phase is lost because of a blown fuse, electric motors can continue to operate (single phasing) which can result in severe electrical or mechanical damage. For permanent installations, this relay should be used to monitor the incoming supply, protecting all equipment against incorrect connection at initial installation or after maintenance work. Rotating machines that cannot tolerate reverse rotation or pose significant risk to personnel under this condition should be individually protected with this relay. The possibility of incorrect supply connection is much more likely in portable equipment or marine applications.

The phase sequence and phase failure protectors continuously monitor the three phase supply. With the correct phase sequence applied, the front panel LED will illuminate and the output relay will be energised. An incorrect sequence or missing phase will de-energise the relay, and the LED will be extinguished. If the supply drops below 85% of its nominal voltage, this condition will also cause a trip.

Note: If one phase is lost due to a blown fuse, some loads can re-generate the missing voltage. This relay can be used as a phase failure relay providing the regenerated voltage in the open phase is less than 70% of the nominal supply voltage. If there is the possibility of a higher regenerated voltage, the phase balance relay 252-PSF should be used.

Features

- Three phase, 3 or 4 wire
- LED trip indication
- Double pole relay contacts
- Automatic reset

Benefits

- Monitoring of correct phase rotation
- Protection against incorrect phase sequence and loss of phase
- Under voltage monitoring
- Prevents reverse rotation of motor driven equipment
- Ensures correct engine rotation
- Protects portable electrical equipment

Applications

- Marine panels
- Switchgear
- Distribution systems
- Generator sets
- Control panels
- Process control
- Motor protection
- Transformers
- Overload protection

Approvals

- UL, CSA, BV and ABS

Product Codes

Relay	Protection	ANSI No.	Catalogue No.
3 phase 3 or 4 wire	Phase sequence, under voltage 85%	47	252-PVR

Specify system voltage, frequency and required options at time of ordering.

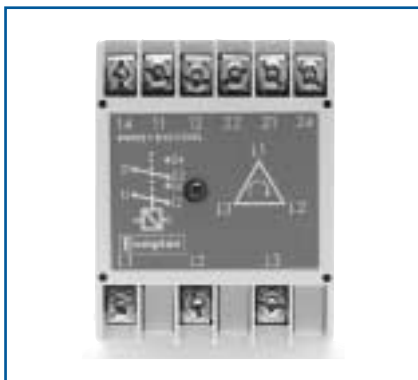

Specification – Phase Sequence and Phase Failure

Nominal Voltage	110V, 120V, 208V, 220V, 230V, 240V, 277V, 380V, 400V, 415V, 440V or 480V
Nominal Frequency	50, 60 or 400Hz
Voltage Burden	3VA approx.
Overload	1.2 x rating continuously, 1.5 x rating for 10 x seconds to symmetric
Trip Level Adjustment	Preset at 85% of nominal
Auxiliary Voltage Burden	4VA (max)
Output Relay	Double pole change over
Relay Contact Rating	AC: 240V 5A, non inductive DC: 24V, 5A resistive
Relay Mechanical Life	0.2 million operations at rated loads
Relay Reset	Automatic
Operating Temperature	0°C to +60°C (0°C to +40°C for UL models)
Storage Temperature	-20°C to + 70°C
Temperature Co-efficient	0.05% per °C
Interference Immunity	Electrical stress surge withstand and non-function to ANSI/IEEE C37 90a
Enclosure Style	DIN rail with wall mounting facility
Material	Flame retardant polycarbonate/ABS
Enclosure Integrity	IP50
Compliant With	EMC, LVD, US Safety Standard IEC 414 UL File No: E113067 recognised up to 600V CSA File No: LR52592 up to 300V BV File No: 2650H-07427-AO PRSO BV ABS File No: 93-LD 17806-X
Model 252 Dimensions	55mm (2.2") wide x 70mm (2.8") high x 112mm (4.4") deep
Weight	0.4Kg approx.

Connections

252-PVR

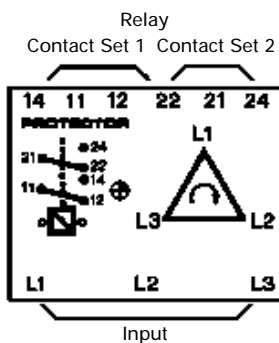

Note: No neutral connection is required.

Dimensions

Model 252

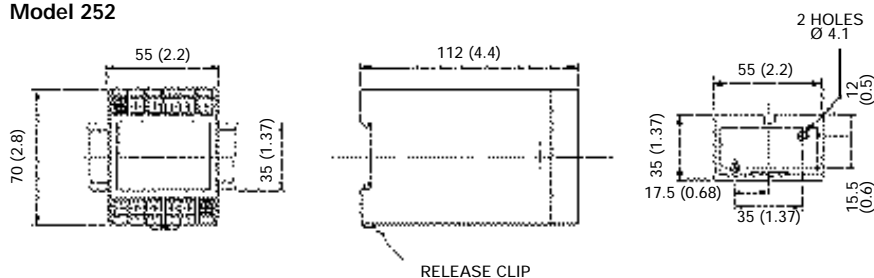

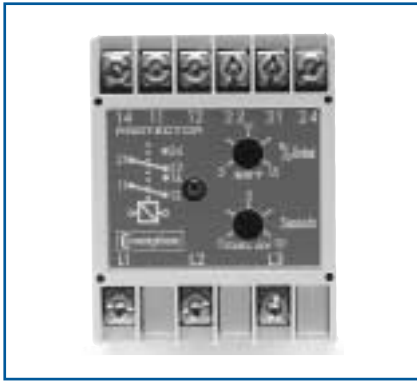

Phase Balance

The 250 series phase balance protector module provides continuous surveillance of a 3 phase, 3 or 4 wire system and monitors the correct phase rotation or sequence of three phase supply systems. The module protects against phase loss, reversal or sequence, phase unbalance, and system under voltage.

Operation

Rotating machines are particularly vulnerable to incorrect phase sequence. Three phase motors can rotate in the wrong direction, potentially leading to physical damage or the risk of injury to personnel, yet voltage and current readings may appear normal. If one phase is lost because of a blown fuse, electric motors can continue to operate (single phasing) which can result in severe electrical or mechanical damage. This relay has the added advantage that it will detect the phantom or regenerated phase that can be caused by a single phase failure on some equipment or when running motors at low load levels.

An unbalanced supply voltage can lead to temperature rises in motors. An unbalance voltage as little as 10% can increase operating temperature to 150% of normal. For permanent installations, this relay should be used to monitor the incoming supply, protecting all equipment against incorrect connection at initial installation or after maintenance work. Rotating machines that cannot tolerate reverse rotation or pose significant risk to personnel under this condition should be individually protected with this relay. The possibility of incorrect supply connection is much more likely in portable equipment or marine applications.

The protector continuously monitors the three phase supply. With the correct phase sequence applied and all three voltages balanced within the required limits, the front panel LED will illuminate and the output relay will be energised. An incorrect sequence, missing phase, out of balance or under voltage condition will de-energise the relay, and the LED will be extinguished.

The setpoint control allows adjustment of the voltage matching between 5% and 15%. The time delay function operates only for the voltage unbalance condition. The delay can be used to prevent nuisance tripping due to short term unbalance situations. Incorrect phase rotation, a missing phase or an under voltage condition trip the relay immediately.

Product Codes

Relay	Protection	ANSI No.	Catalogue No.
3 phase 3 or 4 wire	Phase loss and unbalance 5 - 15%	47	252-PSF
3 phase 3 or 4 wire	Phase loss, unbalance and under voltage 5-15%	47/27	252-PSG

Specify system voltage, frequency and required options at time of ordering.

Features

- Three phase, 3 or 4 wire
- Adjustable setpoint
- Adjustable time delay
- Internal differential
- LED trip indication
- Double pole relay contacts
- Automatic reset

Benefits

- Monitoring of correct phase rotation
- Protects against phantom or regenerated phase voltage
- Protection against phase loss, reversal or sequence
- Under voltage and unbalanced voltage monitoring
- Prevents reverse rotation of motor driven equipment
- Ensures correct engine rotation
- Protects portable electrical equipment
- Nuisance tripping avoidance

Applications

- Marine panels
- Switchgear
- Distribution systems
- Generator sets
- Control panels
- Process control
- Motor protection
- Transformers
- Overload protection

Approvals

- UL, CSA, BV and ABS

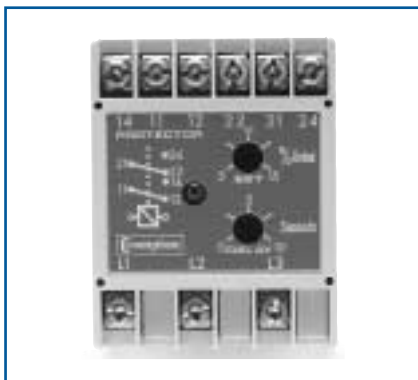

Specification – Phase Balance

Nominal Voltage	110V, 120V, 208V, 220V, 230V, 240V, 277V, 380V, 400V, 415V, 440V or 480V
System Frequency	50 or 60Hz
Voltage Burden	3VA approx.
Overload	1.2 x rating continuously, 1.5 x rating for 10 x seconds
Set Point Repeatability	>0.5% of full span
Under Voltage Setpoint	Preset at 15% of nominal voltage. Other values 10 to 30% to order (Model 252-PSG only)
Trip Level Adjustment	Phase unbalance adjustable 5 to 15%
Time Delay	10 seconds as standard. Up to 30 seconds available
Auxiliary Voltage Burden	4VA (max)
Output Relay	Double pole change over
Relay Contact Rating	AC: 240V 5A, non inductive DC: 24V, 5A resistive
Relay Mechanical Life	0.2 million operations at rated loads
Relay Reset	Automatic
Operating Temperature	0°C to +60°C (0°C to +40°C for UL models)
Storage Temperature	-20°C to + 70°C
Temperature Co-efficient	0.05% per °C
Interference Immunity	Electrical stress surge withstand and non-function to ANSI/IEEE C37 90a
Enclosure Style	DIN rail with wall mounting facility
Material	Flame retardant polycarbonate/ABS
Enclosure Integrity	IP50
Compliant With	EMC, LVD, Safety Standard IEC 414 UL File No: E113067 recognised up to 600V CSA File No: LR52592 up to 600V BV File No: 2650H-07427-AO PRSO BV ABS File No: 93-LD 17806-X
Model 252 Dimensions	55mm (2.2") wide x 70mm (2.8") high x 112mm (4.4") deep
Weight	0.4Kg approx.

Connections

252-PSF
252-PSG

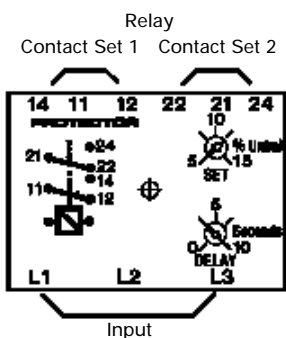

Note: Neutral connection not required

Dimensions

Model 252

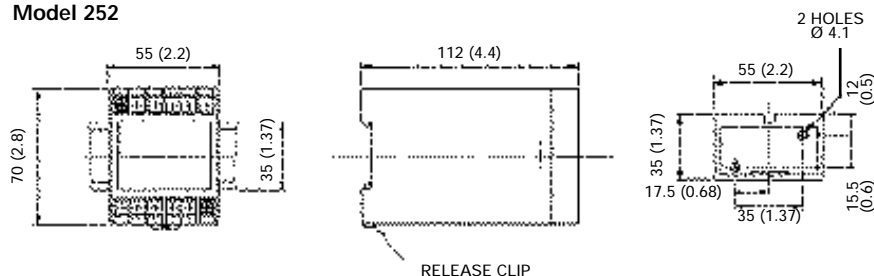



Reverse Power (Current)

The reverse power protector provides continuous surveillance for A.C. generators operating in parallel or for boosting mains supplies. On site adjustment of the trip point and time delay ensures accurate protection against 'motoring' in the event of engine failure and prevents tripping from surges during synchronising.

Operation

Reverse power protectors provide continuous surveillance of AC generators against motoring. Reverse power relays are used to detect the failure of the prime mover (engine) when active energy (Watts) flows into the generator causing rotation - the set will operate like an electric motor, which can cause significant mechanical damage. This relay offers an adjustable reverse power setpoint between 2% and 20% of nominal power, and time delay adjustment range of 0 to 20 seconds.

As soon as the reverse power level increases above the setpoint limit, the time delay is activated, after which a trip will occur. The time delay prevents the relay from tripping for a predetermined period to prevent nuisance tripping. The products also feature an internal differential (hysteresis) setting of 1% to reduce nuisance tripping if the measured signal is noisy or unstable. These units are powered from the measuring supply.

The protector relay approximates the power level in the system by measuring current and power factor, but does not actually measure the system voltage. When the reverse power level exceeds the setpoint, the time delay is started. When the time has elapsed, the relay will energise and the red LED will illuminate to indicate the trip condition. The relay will automatically reset once the power level falls below the setpoint minus the differential, the LED will extinguish and the relay de-energises. The time delay is not active when resetting. The reverse power level will trip as expected at the calibrated point for unity power factor, however, the system power factor does affect the trip point calibration. The relay becomes more sensitive at lagging power factors, as almost all systems exhibit inductance. At leading power factors, this relay is less sensitive.

Setting Up

The "% set" potentiometer trimmer on the front label is calibrated as a percentage of the input current rating e.g. of 5A, and not of the forward kW. Adjust the "% set" trimmer to the required tripping value, 7.5% to 10% is normal. Setting accuracy can be checked by reversing the current lead connections and, with forward power, measuring the trip point value on a suitable ammeter (reconnect leads on completion). Adjust the 'Delay' to the required time delay, 10 seconds is normally adequate.

Options

250 series protector relays offer various customised options to suit individual requirements. Please consult factory.

- Adjustment ranges - different adjustment ranges are possible for the setpoint and time delay controls.
- Relay operation - standard models are fail safe, but the relays can be customised to de-energise on trip.

Product Codes

Relay	Protection	ANSI No.	Catalogue No.
Single phase or 3 phase 4 wire	Reverse power 2 - 20%	32	256-PAS
Single phase or 3 phase 4 wire push to test	Reverse power 2 - 20%	32	256-PAQ
3 phase 3 wire push to test	Reverse power 2 - 20%	32	256-PAR
3 phase 3 wire	Reverse power 2 - 20%	32	256-PAT

Specify system voltage, frequency and required options at time of ordering.

Features

- Three phase, 3 or 4 wire
- Adjustable setpoint
- Adjustable time delay
- Internal differential
- LED trip indication
- Double pole relay contacts
- Automatic reset

Benefits

- Current and power factor measurement
- Protects generators against 'motoring'
- Detects reverse power under fault conditions
- Customised options
- Nuisance tripping avoidance

Applications

- Marine panels
- Switchgear
- Distribution systems
- Generator sets
- Control panels
- Process control
- Motor protection
- Transformers
- Overload protection

Approvals

- UL, CSA, BV and ABS



Dimensions

Model 256

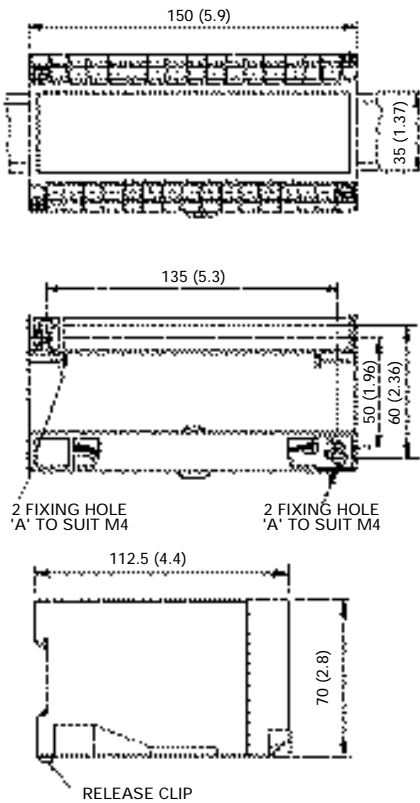

Specification – Reverse Power (Current)

Nominal Voltage	100V, 110V, 120V, 220V, 230V, 240V, 277V, 380V, 400V, 415V, 440V or 480V
Nominal Current	5A or 2, 3, 4, 6, 8 and 10A
System Frequency	50, 60 or 400Hz
Burden	Voltage: 3VA maximum Current: 2VA maximum
Current Overload	2 x rating continuously, 10 x rating for 3 seconds
Voltage Overload	1.2 x rating continuously, 1.5 x rating for 10 seconds
Monitoring Range	Power Factor: 0.5 inductive/unity/0.2 capacitive Current: 20 to 100% of nominal input
Set Point Repeatability	>0.5% of full span
Differential (Hysteresis)	Preset at 1%
Trip Level Adjustment	2 to 20%. Customised adjustment available.
Time Delay Adjustable	0 to 20 seconds
AC Auxiliary Supply Voltage	100V, 110V, 120V, 208V, 220V, 240V, 480V, ±20%
Auxiliary Voltage Burden	4VA (max)
Output Relay	Double pole change over
Relay Contact Rating	AC: 240V 5A, non inductive DC: 24V, 5A resistive
Relay Mechanical Life	0.2 million operations at rated loads
Relay Reset	Automatic
Operating Temperature	0°C to +60°C (0°C to +40°C for UL models)
Storage Temperature	-20°C to + 70°C
Temperature Co-efficient	0.05% per °C
Interference Immunity	Electrical stress surge withstand and non-function to ANSI/IEEE C37 90a
Enclosure Style	DIN rail with wall mounting facility
Material	Flame retardant polycarbonate/ABS
Enclosure Integrity	IP50
Compliant With	EMC, LVD, Safety Standard IEC 414 UL File No: E113067 recognised up to 600V CSA File No: LR52592 up to 300V BV File No: 2650H-07427-AO PRSO BV ABS File No: 93-LD 17806-X
Dimensions	150mm (5.9") wide x 70mm (2.8") high x 112mm (4.4") deep
Weight	1.0kg approx.

Connections

- 256-PAS
- 256-PAT
- 256-PAQ
- 256-PAR

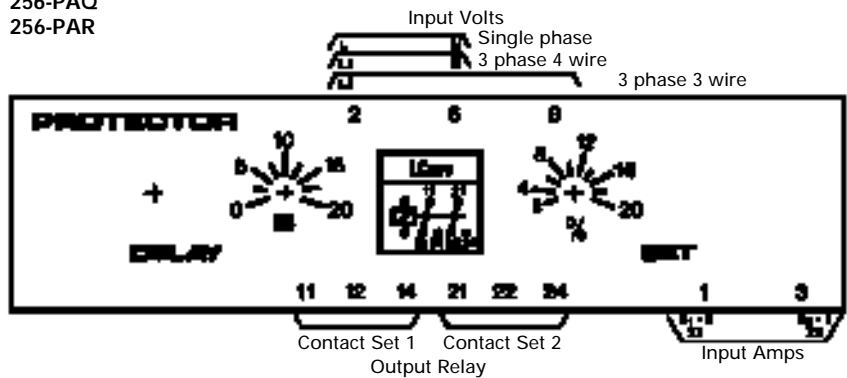

Note: Only one CT connection is required, from the same phase as the voltage connection to terminal 2.



Synchro-Check (parallelling)

The synchro-check relay can be used to assist in the semi-automatic parallelling of two AC power systems. The volt-free relay contacts change state when the voltage level, phase relationship and frequency are within the selected synchronising limits. Connecting two electrical systems that are not closely matched can cause expensive damage and disturbance to the electrical system. Using this relay will ensure that damage will not occur.

Operation

As part of a manual control system, the operator will make adjustments to the generator voltage (excitation) and frequency (engine speed) using a synchroscope or lamps, and will then attempt to manually close the breaker. This synchro check protector will qualify that the two systems are closely matched before permitting the breaker to close. As part of an automatic synchronising arrangement, this relay can be used as an independent backup or checking device to ensure the two systems are suitably matched before the breaker can close.

Features

- Single phase or three phase, 3 or 4 wire
- Live and dead bus versions
- Adjustable setpoint
- LED trip indication
- Volt free relay contacts

Benefits

- Monitors voltage phase displacement and frequency of 2 supplies
- Frequency matching
- Voltage matching
- Phase angle matching
- Synchronisation of Gen-Bus and Bus-Bus
- Monitors auto synchronising systems
- Assists in manual synchronisation

Applications

- Marine panels
- Switchgear
- Distribution systems
- Generator sets
- Co-generation
- Control panels

Approvals

- UL, BV and ABS

Model 256-PLL

The relay continuously monitors the voltage, phase displacement and frequency of two supplies. A single setpoint adjustment permits selection of suitable matching, and a red LED illuminates when the relay is energised, indicating that the two supplies are well matched and it is safe to close the breaker.

Model- 256-PLD

This version operates in the same way as model 256-PLL, but includes an additional dead bus detection function. If there is a requirement for a continuous supply or emergency power, then the generator can be connected without synchronising, thus ensuring continuity of supply. The absence of bus voltage will cause the relay to energise.

Product Codes

Relay	Protection	ANSI No.	Catalogue No.
Single phase, or 3 phase 3 or 4 wire	Phase angle and voltage	25	256-PLL
Single phase, or 3 phase 3 or 4 wire	Phase angle and voltage Dead bus	25	256-PLD

Specify system voltage, frequency and required options at time of ordering.



Dimensions

Model 256

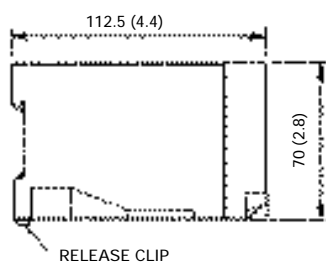
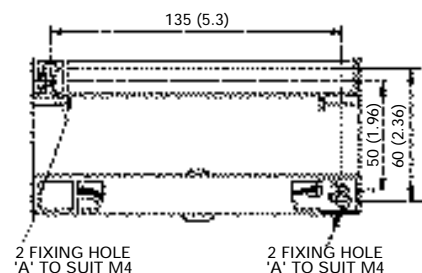
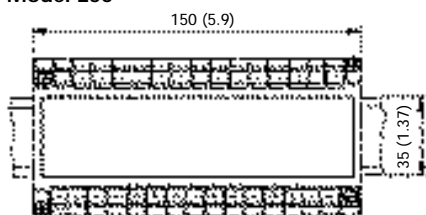

Specification – Synchro-Check (parallelling)

Nominal Voltage	100V, 110V, 120V, 208V, 220V, 230V, 240V, 277V, 380V, 400V, 415V, 440V or 480V
System Frequency	45, 50, 55, 60 or 65Hz
Burden	Bus: 2VA Generator: 4VA
Overload	-25 to +30% of the nominal voltage
Set Point Repeatability	>0.5% of full span
Differential (Hysteresis)	Preset at 1%. Values 1% to 10% available on request
Trip Level	10 to 30% of the nominal voltage. 6° to 20° electrical adjustment
Output Relay	1 pair NO (normally open), 1 pair NC (normally closed) 2 pair NO and 2 pair NC available on request
Relay Contact Rating	AC: 240V 5A, non inductive DC: 24V, 5A resistive
Relay Mechanical Life	0.2 million operations at rated loads
Relay Reset	Automatic
Operating Temperature	0°C to +60°C (0°C to +40°C for UL models)
Storage Temperature	-20°C to + 70°C
Temperature Co-efficient	0.05% per °C
Interference Immunity	Electrical stress surge withstand and non-function to ANSI/IEEE C37 90a
Enclosure Style	DIN rail with wall mounting facility
Material	Flame retardant polycarbonate/ABS
Enclosure Integrity	IP50
Compliant With	EMC, LVD, Safety Standard IEC 414 UL File No: E113067 recognised up to 600V BV File No: 2650H-07427-AO PRSO BV ABS File No: 93-LD 17806-X
Dimensions	150mm (5.9") wide x 70mm (2.8") high x 112mm (4.4") deep
Weight	1.0kg approx.

Connections

256-PLL 256-PLD

System	Generator Connections	Busbar Connections
3 phase 4 wire	1 2 L1 N	3 4 L1 N
3 phase 3 wire	L1 L2	L1 L2
1 phase 2 wire	L1 N	L1 N

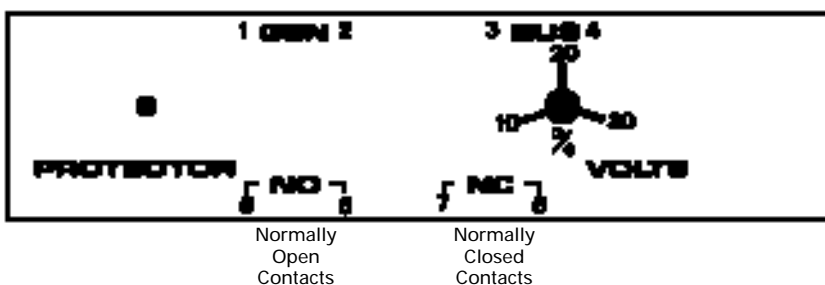

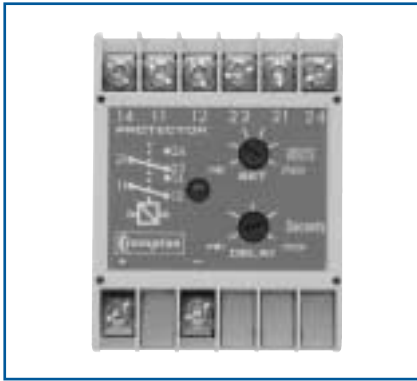

D.C. Voltage

DC voltage protectors provide continuous surveillance of the monitored voltage circuit, typically a battery supply or charging circuit. When the measured voltage moves outside the set-point limits, the relay will operate after the selected time delay or differential, giving an alarm and/or initiation signal. The protectors offer protection for under voltage, over voltage and battery level control.

Operation

DC voltage protectors offer user adjustable trip point (setpoint) and time delay settings. The time delay setting adjustment range is typically 0 to 10 seconds, although longer delays up to 30 seconds are available. As soon as the monitored signal moves outside of the setpoint limit, the time delay is activated, after which a trip will occur. The time delay prevents the relay from tripping for a predetermined period to prevent nuisance tripping. The products also feature an internal differential (hysteresis) setting of 1% to reduce nuisance tripping if the measured signal is noisy or unstable. The units draw their operating power from the measuring inputs.

Features

- Adjustable setpoint
- Adjustable time delay
- Internal differential
- LED trip indication
- Automatic reset
- Double pole relay contacts

Benefits

- Over and under voltage monitoring
- Monitors correct terminal voltage on battery supplies
- Monitors charging voltage on battery chargers
- Battery level control
- Nuisance tripping avoidance
- Customised options

Applications

- Marine panels
- Switchgear
- Distribution systems
- Generator sets
- Control panels
- Process control
- Overload protection

Approvals

- UL recognised

Over Voltage Models

When the monitored voltage exceeds the setpoint, the time delay is started. When the time has elapsed, the relay will energise and the red LED will illuminate to indicate the trip condition. The relay will automatically reset once the monitored voltage falls below the setpoint minus the differential. When reset, the LED will extinguish and the relay de-energises. The time delay is not active when resetting.

Under Voltage Models

When the monitored voltage falls below the setpoint, the time delay is started. When the time has elapsed, the relay will de-energise and the red LED will extinguish to indicate the trip condition. The relay will automatically reset once the monitored voltage rises above the setpoint plus the differential. When reset, the LED will illuminate and the relay energises. The time delay is not active when resetting.

Options

250 series protector relays offer various customised options to suit individual requirements. Please consult factory.

- Adjustment ranges - different adjustment ranges are possible for the setpoint and time delay controls.
- Differential - Internally fixed value between 1% and 15%.
- Relay operation - standard models are fail safe, but the relays can be customised to energise or de-energise on trip.

Product Codes

Relay	Protection	ANSI No.	Catalogue No.
DC Voltage	Under voltage external time delay	27	252-PDU
DC Voltage	Under voltage differential	27	252-PDE
DC Voltage	Over voltage external time delay	59	252-PDO
DC Voltage	Over and under voltage external time delay	27/59	253-PDC

Specify system voltage, frequency and required options at time of ordering.

Connections

252-PDU
252-PDO

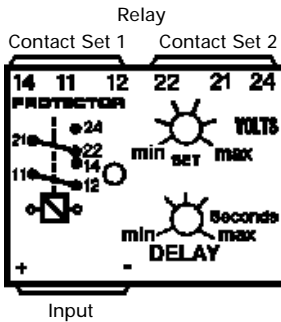

252-PDE

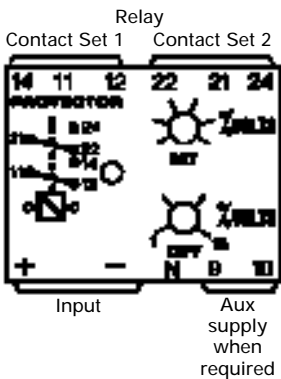

253-PDC

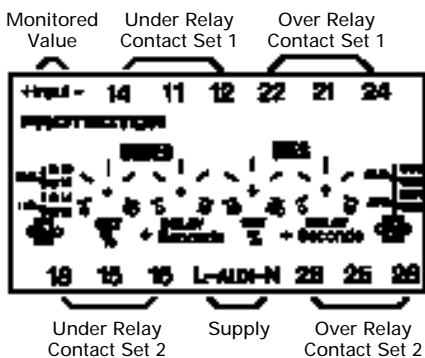

Specification - D.C. Voltage

Nominal Voltage	18 to 20V DC or 20 to 32V DC
Voltage Burden	<3VA
Overload	1.2 x rating continuously
Set Point Repeatability	>0.5% of full span
Differential (Hysteresis)	Models 252-PDU, 252-PDO & 253-PDC: Preset at 1%. Values 1% to 15% available on request Model 252-PDE: Adjustable 1 to 15%
Time Delay Adjustment	Models 252-PDU, 252-PDO & 253-PDC: 0-10, 0-20, 0-30 seconds Model 252-PDE: Factory pre-set up to 30 seconds.
AC Auxiliary Supply Voltage	100V, 110V, 120V, 208V, 220V, 240V, 480V, ±20%
DC Auxiliary Supply Voltage	12V, 24V, 48V, 110V or 125V, ±15%. Max ripple 15%
Auxiliary Voltage Burden	4VA (max)
Output Relay	Double pole change over
Relay Contact Rating	AC: 240V 5A, non inductive DC: 24V, 5A resistive
Relay Mechanical Life	0.2 million operations at rated loads
Relay Reset	Automatic
Operating Temperature	0°C to +60°C (0°C to +40°C for UL models)
Storage Temperature	-20°C to + 70°C
Temperature Co-efficient	0.05% per °C
Interference Immunity	Electrical stress surge withstand and non-function to ANSI/IEEE C37 90a
Enclosure Style	DIN rail with wall mounting facility
Material	Flame retardant polycarbonate/ABS
Enclosure Integrity	IP50
Compliant With	EMC, LVD, Safety Standard IEC 414 UL File No: E113067 recognised up to 600V
Model 252 Dimensions	55mm (2.2") wide x 70mm (2.8") high x 112mm (4.4") deep
Model 253 Dimensions	75mm (2.9") wide x 70mm (2.8") high x 112mm (4.4") deep
Weight	Model 252: 0.4Kg approx. Model 253: 0.6Kg approx

Dimensions

Model 252

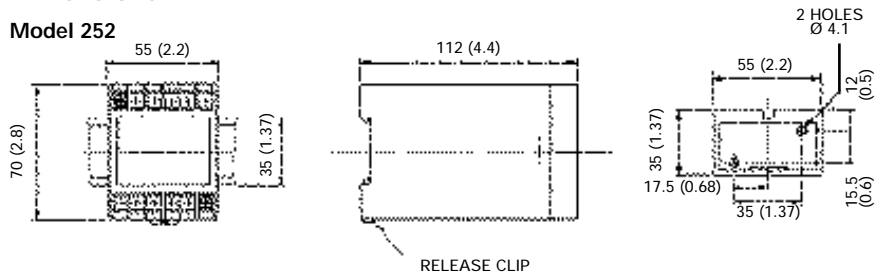

Connections

Model 253

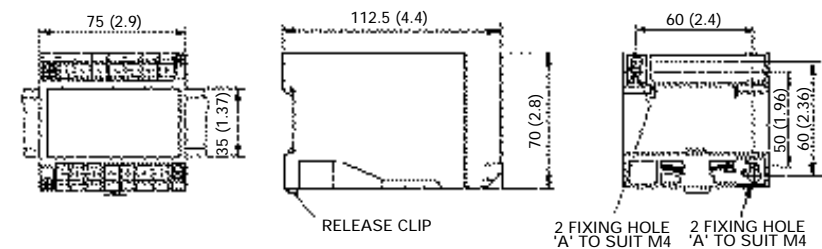

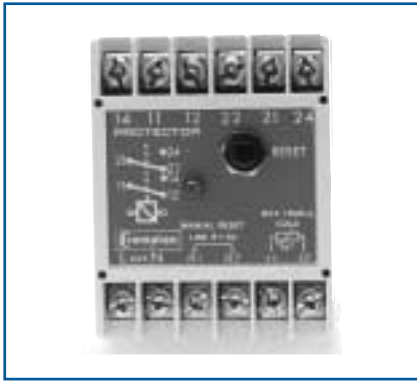

Thermistor Trip

Many motors, transformers and generators are fitted with positive temperature coefficient thermistor temperature sensors, the addition of a thermistor trip relay will provide full protection against sustained overload, single phasing, locked rotor, blocked ventilation and high ambient temperature. Thermistor trip relays continuously monitor the working temperature inside electrical equipment. When the temperature exceeds a safe limit, the relay can be used to shut equipment down until it regains a safe operating temperature.

Operation

Thermistors are simple low cost temperature sensors. The thermistor trip protector operates by de-energising a relay when the thermistors detect a critical temperature condition. An illuminated green LED indicates when the temperature is within normal working limits. Any number of thermistors may be used in series connection providing the resistance at normal working temperature is less than 1500 ohms.

There are no user adjustments on this relay.

Model 252-PMT will automatically reset when temperature returns to normal. For Model 252-PMM, fitting a link between terminals R1 and R2 will latch the product in its tripped state when an over temperature condition is detected. The relay can be reset by pressing the front panel reset switch, opening the R1 - R2 link, or interrupting the auxiliary supply.

Product Codes

Relay	Protection	ANSI No.	Catalogue No.
PTC Thermistors	Over temperature, manual reset	49	252-PMM
PTC Thermistors	Over temperature, automatic reset	49	252-PMT

Specify system voltage and required options at time of ordering.

Features

- Trip range 2500 to 3500 ohms
- Reset range 1500 to 2300 ohms
- LED trip indication
- Automatic or manual reset options
- Double pole relay contacts

Benefits

- High temperature protection
- Sustained overload protection
- Single phasing protection
- Locked rotor protection
- Blocked ventilation protection

Applications

- Switchgear
- Distribution systems
- Generator sets
- Control panels
- Process control
- Motor protection
- Transformers
- Overload protection

Approvals

- UL and CSA

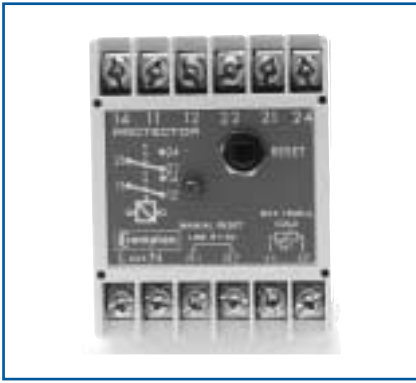

Specification – Thermistor Trip

Nominal Voltage	110V, 120V, 220V, 230V or 240V AC $\pm 20\%$.
Input	Positive temperature coefficient thermistors (series connected 1500 Ω at normal temperature)
System Frequency	50/60Hz
Voltage Burden	2VA approx
Overload	1.2 x rating continuously
Trip Level	2500 to 3500 Ω reset 1500 to 2300 Ω
AC Auxiliary Supply Voltage	100V, 110V, 120V, 208V, 220V, 240V, 480V, $\pm 20\%$
DC Auxiliary Supply Voltage	12V, 24V, 48V, 110V or 125V, $\pm 15\%$. Max ripple 15%
Auxiliary Voltage Burden	4VA (max)
Output Relay	Double pole change over
Relay Contact Rating	AC: 240V 5A, non inductive DC: 24V, 5A resistive
Relay Mechanical Life	0.2 million operations at rated loads
Relay Reset	Model 252-PMT: Automatic Model 252-PMM: Manual
Operating Temperature	0°C to +60°C (0°C to +40°C for UL models)
Storage Temperature	-20°C to +70°C
Temperature Co-efficient	0.05% per °C
Interference Immunity	Electrical stress surge withstand and non-function to ANSI/IEEE C37 90a
Enclosure Style	DIN rail with wall mounting facility
Material	Flame retardant polycarbonate/ABS
Enclosure Integrity	IP50
Compliant With	EMC, LVD, Safety Standard IEC 414 UL File No: E113067 recognised up to 600V CSA File No: LR52592 up to 300V
Model 252 Dimensions	55mm (2.2") wide x 70mm (2.8") high x 112mm (4.4") deep
Weight	0.4Kg approx.

Connections

252-PMT

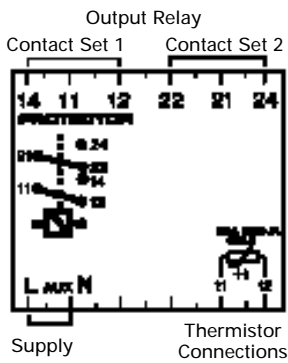

252-PMM

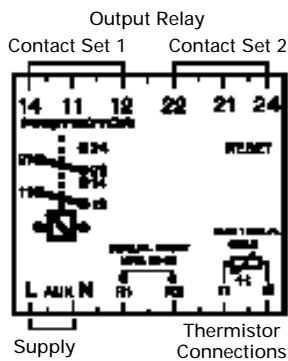

Dimensions

Model 252

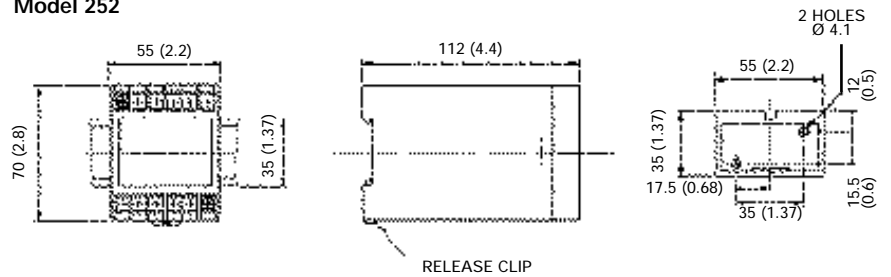



Hot Spot 3 Temperature Relay

The Hot Spot 3 relay accepts up to three inputs from resistance temperature detectors (RTD) and provides up to three user adjustable trip points which can be used to initiate alarms, cooling systems or shutdown. The relay is ideally suited for the protection of electric motor windings, transformers, generator windings and bearing temperature. The analogue output can be used for remote monitoring of high temperatures.

Operation

RTD temperature sensors are often fitted inside electric motors to detect hot spots in the windings or the bearings. RTD sensors are popular because they offer a good accuracy for a reasonable price. The same sensors can be used inside transformers, generator sets, gas turbines or as part of a process control system. Hot spots can be caused by many conditions, such as overloads, over voltage, unbalanced supply, worn bearings, ineffective cooling, poor ventilation, shorted turns, insulation breakdown, single phasing etc.

The Hot Spot 3 protector continuously monitors the three RTD temperature sensors, and offers up to three user adjustable setpoints and relay contacts. These can be used to raise alarms, switch on cooling systems or shut down the effected equipment. The highest temperature is indicated with a yellow LED, and can be accurately measured or remotely displayed using the 0/1mA analogue output signal.

The temperature is compared with the user adjustable setpoints. When the measured temperature exceeds the setpoint, the relay will de-energise, and a red LED illuminated to indicate the trip condition. When the temperature drops below the setpoint, the relay will reset to the energised condition, and the LED will extinguish. The range consists of three product models which offers one, two or three adjustable setpoints.

Product Codes

Relay	Protection	ANSI No.	Catalogue No.
3 RTD inputs	3 set points	49	256-PRA
3 RTD inputs	2 set points	49	256-PRB
3 RTD inputs	1 set point	49	256-PRC

When ordering please supply the following information:

- System voltage, frequency and required options.
- The type of temperature sensor being used, e.g. Platinum PT100.
- The maximum temperature or meter scale, e.g. 100% = 1mA = 150°C.
- The setpoint adjustment range, e.g. 0°C to 150°C.

Features

- Up to 3 RTD inputs
- 1mA analogue output
- 3 adjustable setpoints
- Internal differential
- LED trip indication
- Automatic reset
- 3 single pole relay contacts

Benefits

- Temperature monitoring
- Unbalanced supply protection
- Sustained overload protection
- Single phasing protection
- Blocked ventilation protection
- Protection against ineffective cooling
- Protection of bearing temperature

Applications

- Switchgear
- Distribution systems
- Generator sets
- Control panels
- Process control
- Motor monitoring
- Transformers
- Overload protection

Approvals

- UL recognised



Dimensions

Model 256

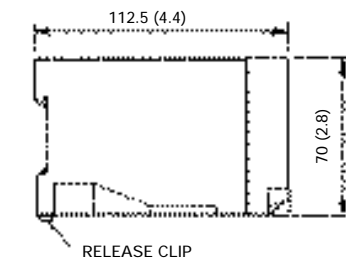
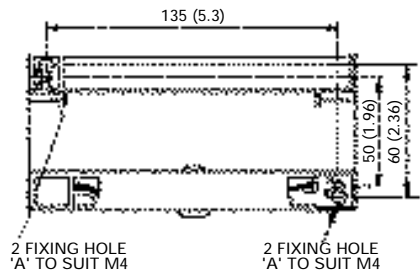
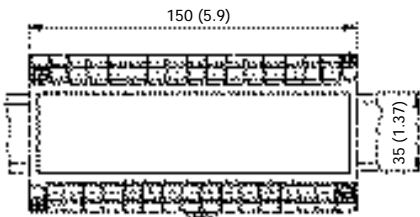

Specification – Hot Spot 3 Temperature Relay

Input	Up to 3 resistance temperature detectors (RTD). Either 10Ω copper or 100Ω platinum minimum span 100°C
Nominal Voltage	AC: 110V, 120V, 220V, 230V, or 240V ± 20% DC: Consult Factory
System Frequency	50/60Hz
Overload	1.2 x rating continuously
Set Point Repeatability	0.5% of full span
Differential (Hysteresis)	Preset at 2% of range
AC Auxiliary Supply Voltage	100V, 110V, 120V, 208V, 220V, 240V, 480V, ±20%
DC Auxiliary Supply Voltage	12V, 24V, 48V, 110V or 125V, ±15%. Max ripple 15%
Auxiliary Voltage Burden	4VA (max)
Analogue Output	1mA into 0/4kΩ load
Output Relay	Single pole change over
Relay Contact Rating	AC: 240V 5A, non inductive DC: 24V, 5A resistive
Relay Mechanical Life	0.2 million operations at rated loads
Relay Reset	Automatic
Operating Temperature	0°C to +60°C (0°C to +40°C for UL models)
Storage Temperature	-20°C to + 70°C
Temperature Co-efficient	0.05% per °C
Interference Immunity	Electrical stress surge withstand and non-function to ANSI/IEEE C37 90a
Enclosure Style	DIN rail with wall mounting facility
Material	Flame retardant polycarbonate/ABS
Enclosure Integrity	IP50
Compliant With	EMC, LVD, Safety Standard IEC 414 UL File No: E113067 recognised up to 600V
Dimensions	150mm (5.9") wide x 70mm (2.8") high x 112mm (4.4") deep
Weight	1.0kg approx.

Connections

- 256-PRA
- 256-PRB
- 256-PRC

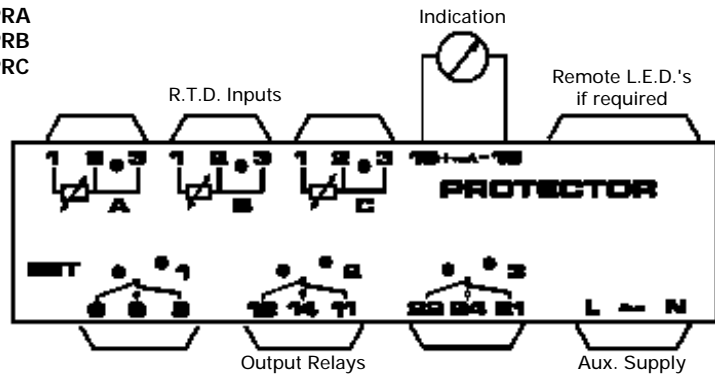

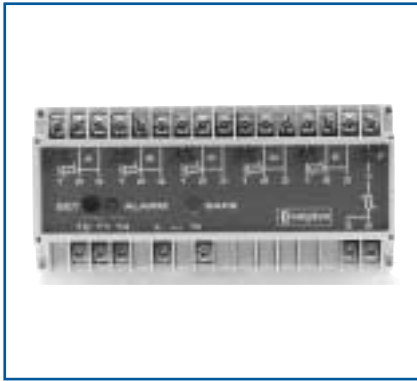

Hot Spot 6 Temperature Relay

The Hot Spot 6 protector is a temperature trip relay accepting up to six inputs from resistance temperature detector (RTD) elements and provides one user adjustable trip point which can be used to initiate alarms, cooling or shutdown when the monitored temperature exceeds the set limit. The relay is ideally suited for the protection of electric motor windings, transformers, generator windings and bearing temperature.

Operation

RTD temperature sensors are often fitted inside electric motors to detect hot spots in the windings or bearings. RTD sensors are popular because they offer a good accuracy for a reasonable price. The same sensors can be used inside transformers, generator sets, gas turbines or as part of a process control system. Hot spots can be caused by many conditions, such as overloads, over voltage, unbalanced supply, worn bearings, ineffective cooling, poor ventilation, shorted turns, insulation breakdown, single phasing etc.

The Hot Spot 6 protector continuously monitors the six RTD temperature sensors, and offers a user adjustable setpoint and relay contacts. This can be used to raise alarms, switch on cooling systems or shut down the effected equipment. The highest of the six temperatures is indicated with a red LED. This temperature is compared with the user adjustable setpoint. When the measured temperature exceeds the setpoint, the relay will de-energise, and the red LED illuminates to indicate the trip condition. When the temperature drops below the setpoint, the relay will reset to the energised condition, and a green LED will illuminate to indicate 'Safe' condition.

Features

- Up to 6 RTD inputs
- Adjustable setpoint
- Internal differential
- LED trip indication
- Automatic reset
- Single pole relay contacts

Benefits

- Unbalanced supply protection
- Sustained overload protection
- Single phasing protection
- Blocked ventilation protection
- Protection against ineffective cooling
- Protection of bearing temperature

Applications

- Switchgear
- Distribution systems
- Generator sets
- Control panels
- Process control
- Motor monitoring
- Transformers
- Overload protection

Approvals

- UL recognised

Product Codes

Relay	Protection	ANSI No.	Catalogue No.
6 RTD inputs	1 setpoint	49	256-PCC

When ordering please supply the following information:

- System voltage, frequency and required options.
- The type of temperature sensor being used, e.g. Platinum PT100.
- The maximum temperature or meter scale, e.g. 100% = 1mA = 150°C
- The setpoint adjustment range, e.g. 0°C to 150°C.

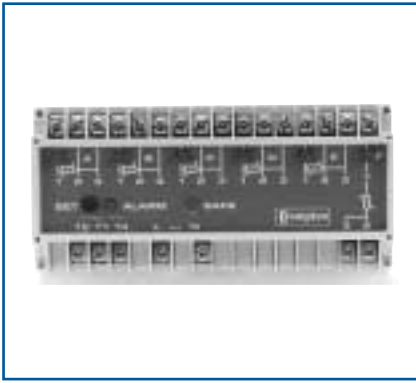

Dimensions

Model 256

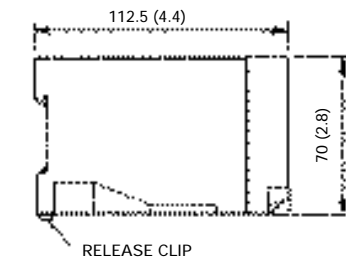
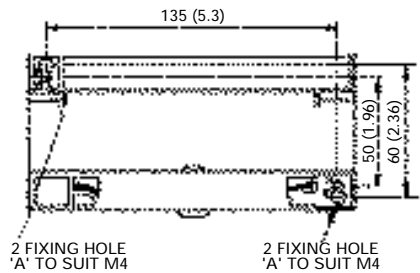
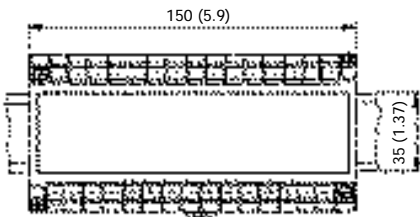

Specification – Hot Spot 6 Temperature Relay

Input	Up to 6 resistance temperature detectors (RTD). Either 10Ω copper or 100Ω platinum minimum span 100°C
Nominal Voltage	AC: 110V, 120V, 220V, 230V, or 240V ± 20% DC: Consult Factory
System Frequency	50/60Hz
Voltage Burden	6VA maximum
Overload	1.2 x rating continuously
Set Point Repeatability	Within 1°C
Differential (Hysteresis)	4°C of nominal
Trip Level Adjustment	100°C (eg: 50 to 150°C, 100 to 200°C etc)
Time Delay	Typically 250ms
AC Auxiliary Supply Voltage	100V, 110V, 120V, 208V, 220V, 240V, 480V, ±20%
DC Auxiliary Supply Voltage	12V, 24V, 48V, 110V or 125V, ±15%. Max ripple 15%
Auxiliary Voltage Burden	4VA (max)
Output Relay	Single pole change over
Relay Contact Rating	AC: 240V 5A, non inductive DC: 24V, 5A resistive
Relay Mechanical Life	0.2 million operations at rated loads
Relay Reset	Automatic
Operating Temperature	0°C to +60°C (0°C to +40°C for UL models)
Storage Temperature	-20°C to + 70°C
Temperature Co-efficient	0.05% per °C
Interference Immunity	Electrical stress surge withstand and non-function to ANSI/IEEE C37 90a
Enclosure Style	DIN rail with wall mounting facility
Material	Flame retardant polycarbonate/ABS
Enclosure Integrity	IP50
Compliant With	EMC, LVD, Safety Standard IEC 414 UL File No: E113067 recognised up to 600V
Dimensions	150mm (5.9") wide x 70mm (2.8") high x 112mm (4.4") deep
Weight	1.0kg approx.

Connections

256-PCC

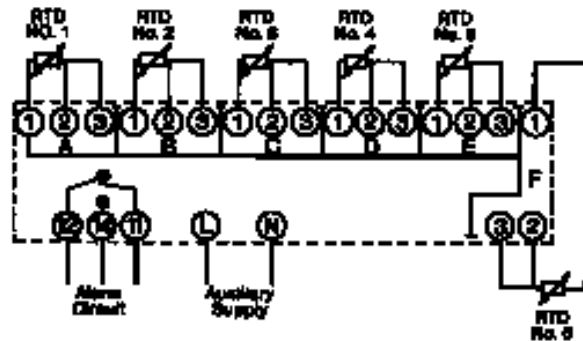

When used for less than 6 RTD inputs the unused terminals 1, 2 & 3 must be linked together.

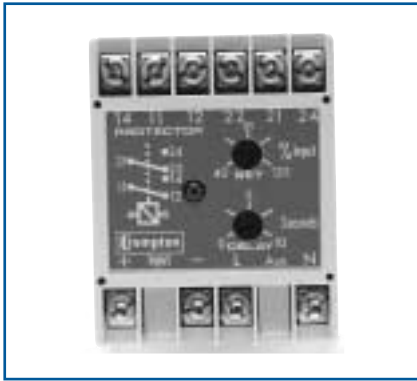

D.C. Millivolts / Thermocouple

The 250 series millivolt protectors provide continuous surveillance of high DC currents when used with current shunts, or can be used to monitor temperatures in conjunction with thermocouples. The protector incorporates a user adjustable trip and time delay which can be set to initiate an alarm when the input exceeds the desired level.

Operation

When used in conjunction with current shunts the millivolt protector can be used to monitor battery charging currents, current drain or over/under current. Monitoring of under / over temperature and detection of hotspots can be achieved in applications using thermocouples. All industry standard shunts, and all popular thermocouples are supported.

The millivolt protector relays offer user adjustable trip point (setpoint) and time delay settings. The time delay setting adjustment range is typically 0 to 10 seconds, although longer delays are available. As soon as the monitored signal moves outside of the setpoint limit, the time delay is activated, after which a trip will occur. The time delay prevents the relay from tripping for a predetermined period to prevent nuisance tripping. These products also feature an internal differential (hysteresis) setting of 1% to reduce nuisance tripping if the measured signal is noisy or unstable. These units require an auxiliary power supply.

'Over' High Trip Models

When the monitored signal exceeds the setpoint, the time delay is started. When the time has elapsed, the relay will energise and the red LED will illuminate to indicate the trip condition. The relay will automatically reset once the monitored signal falls below the setpoint minus the differential. When reset, the LED will extinguish and the relay de-energises. The time delay is not active when resetting.

'Under' Low Trip Models

When the monitored signal falls below the setpoint, the time delay is started. When the time has elapsed, the relay will de-energise and the red LED will extinguish to indicate the trip condition. The relay will automatically reset once the monitored signal rises above the setpoint plus the differential. When reset, the LED will illuminate and the relay energises. The time delay is not active when resetting.

Options

250 series protector relays offer various customised options to suit individual requirements. Please consult factory.

- Adjustment ranges - different adjustment ranges are possible for the setpoint and time delay controls.
- Differential - Internally fixed value between 1% and 15%.
- Relay operation - standard models are failsafe, but the relays can be customised to energise or de-energise on trip.
- Cold junction compensation available on request.

Product Codes

Relay	Protection	ANSI No.	Catalogue No.
DC Millivolt	High trip 40 to 120%	74	252-PBT
DC Millivolt	Low trip 0 to 80%	74	252-PBS
Thermocouple	Type J, K, R, S and T. High trip 40 to 120%	49	252-PTO
Thermocouple	Type J, K, R, S and T. Low trip 0 to 80%	49	252-PTU

For models 252-PBS and 252-PBT specify millivolt input, auxiliary voltage and required options at time of ordering.

For models 252-PTO and 252-PTU specify thermocouple type, nominal temperature, auxiliary voltage and required options at time of ordering.

Features

- High and low trip models
- Adjustable setpoint
- Adjustable time delay
- Internal differential
- LED trip indication
- Automatic reset
- Double pole relay contacts
- Supports all industry standard shunts and popular thermocouples

Benefits

- Under / Over temperature monitoring
- Under / Over current monitoring
- Monitoring of battery charging currents and current drain
- Detection of hotspots
- Nuisance tripping avoidance
- Customised options

Applications

- Switchgear
- Distribution systems
- Generator sets
- Control panels
- Process control
- Motor protection
- Transformers
- Overload protection

Approvals

- UL and CSA

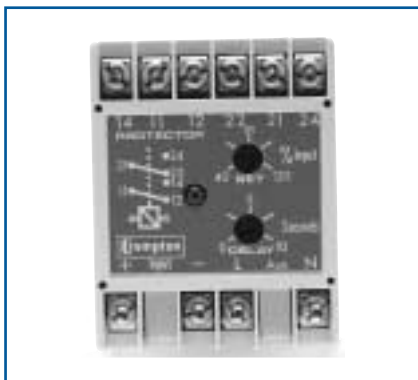

Specification – DC Millivolts / Thermocouple

DC Input	10mV, 50mV, 60mV, 75mV, 100mV, 150mV
Input Impedance	50KΩ
Source Impedance	100Ω maximum
Thermocouple	Types J, K, R, S, T 10 to 50mV
Thermocouple TBP	Thermocouple break protection upscale drive as standard
Thermocouple CJC	Cold junction compensation available on request
Thermocouple Overload	10 x rating continuously
Nominal Frequency	50/60Hz
Voltage Burden	3VA maximum
Voltage Overload	1.2 x rating continuously, 1.5 x rating for 10 seconds
Set Point Repeatability	>0.5% of full span
Differential (Hysteresis)	Preset at 1%. Values 1% to 15% available on request
Trip Level Adjustment	Low trip: 0 to 80% High trip: 40 to 120%
Time Delay Adjustable	0 to 10 seconds
AC Auxiliary Supply Voltage	100V, 110V, 120V, 208V, 220V, 240V, 480V, ±20%
DC Auxiliary Supply Voltage	12V, 24V, 48V, 110V or 125V, ±15%. Max ripple 15%
Auxiliary Voltage Burden	4VA (max)
Output Relay	Double pole change over
Relay Contact Rating	AC: 240V 5A, non inductive DC: 24V, 5A resistive
Relay Mechanical Life	0.2 million operations at rated loads
Relay Reset	Automatic
Operating Temperature	0°C to +60°C (0°C to +40°C for UL models)
Storage Temperature	-20°C to + 70°C
Temperature Co-efficient	0.05% per °C
Interference Immunity	Electrical stress surge withstand and non-function to ANSI/IEEE C37 90a
Enclosure Style	DIN rail with wall mounting facility
Material	Flame retardant polycarbonate/ABS
Enclosure Integrity	IP50
Compliant With	EMC, LVD, Safety Standard IEC 414 UL File No: E113067 recognised up to 600V CSA File No: LR52592 up to 150mV (252-PBS & 252-PBT only)
Dimensions	55mm (2.2") wide x 70mm (2.8") high x 112mm (4.4") deep
Weight	0.4Kg approx.

Connections

- 252-PBT
- 252-PBS
- 252-PTU
- 252-PTO

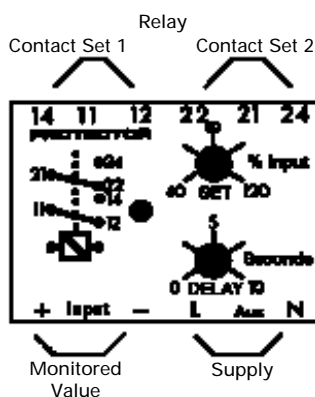

Dimensions

Model 252

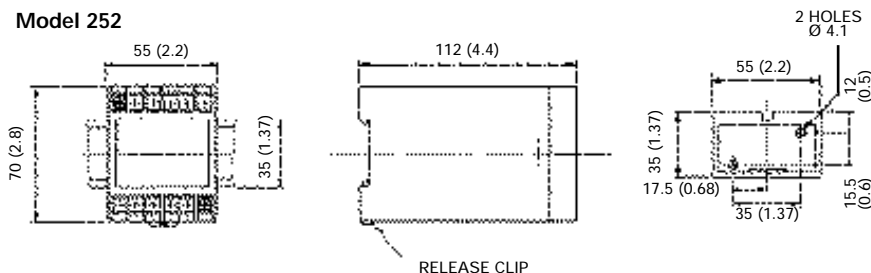

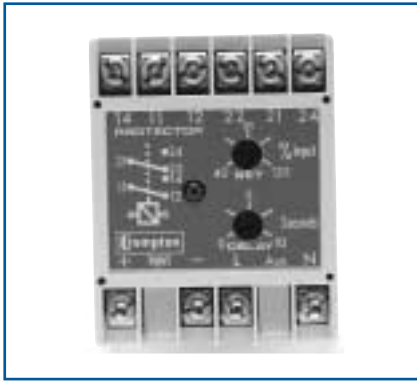

D.C. Transducer Trip

DC transducer protectors provide continuous surveillance of the DC process voltage or current signal. When the standard process signals move outside the setpoint limit the relay will operate. Combining the protection relay with a measuring transducer such as the Crompton 'Paladin' range can form specialised control products whenever self contained relays are not available.

Operation

The DC transducer protector relay offers user adjustable trip point (setpoint) and time delay settings. The time delay setting adjustment range is typically 0 to 10 seconds, although longer delays are available. As soon as the monitored signal moves outside of the setpoint limit, the time delay is activated, after which a trip will occur. The time delay prevents the relay from tripping for a predetermined period to prevent nuisance tripping. The products also feature an internal differential (hysteresis) setting of 1% to reduce nuisance tripping if the measured signal is noisy or unstable. These units require an auxiliary power supply.

Features

- High and low trip models
- Adjustable setpoint
- Adjustable time delay
- Internal differential
- LED trip indication
- Automatic reset
- Double pole relay contacts

Benefits

- Accepts standard process voltage or current signals
- Monitors forward/reverse Watts, VAR and VA
- Monitors under/over Watts, VAR and VA
- Power factor monitoring and control
- Nuisance tripping avoidance
- Customised options

Applications

- Switchgear
- Distribution systems
- Generator sets
- Control panels
- Process control
- Motor protection
- Transformers
- Overload protection

Approvals

- UL and CSA

'Over' High Trip Models

When the monitored signal exceeds the setpoint, the time delay is started. When the time has elapsed, the relay will energise and the red LED will illuminate to indicate the trip condition. The relay will automatically reset once the monitored signal falls below the setpoint minus the differential. When reset, the LED will extinguish and the relay de-energises. The time delay is not active when resetting.

'Under' Low Voltage Models

When the monitored signal falls below the setpoint, the time delay is started. When the time has elapsed, the relay will de-energise and the red LED will extinguish to indicate the trip condition. The relay will automatically reset once the monitored signal rises above the setpoint plus the differential. When reset, the LED will illuminate and the relay energises. The time delay is not active when resetting.

Options

250 series protector relays offer various customised options to suit individual requirements. Please consult factory.

- Adjustment ranges - different adjustment ranges are possible for the setpoint and time delay controls.
- Differential - Internally fixed value between 1% and 15%.
- Relay operation - standard models are fail safe, but the relays can be customised to energise or de-energise on trip.

Product Codes

Relay	Protection	ANSI No.	Catalogue No.
DC Transducer	Low trip 0 to 80%	74	252-PBA
DC Transducer	High trip 40 to 120%	74	252-PBB
DC Transducer	High and low trip	74	253-PBV

Specify, input current/voltage, auxiliary voltage and required options at time of ordering.

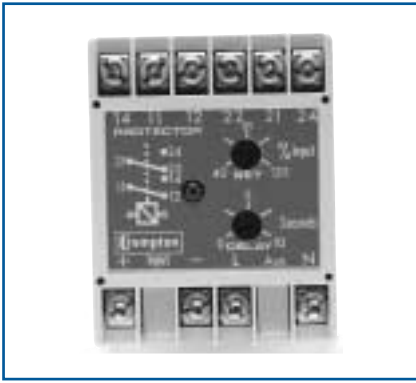

Specification – DC Transducer Trip

Nominal Input Current DC	0-1mA, 0-5mA, 0-10mA, 0-20mA, 4-20mA. Volt drop 1V
Nominal Input Voltage DC	1V to 50V, input resistance 10kΩ/V
Voltage Burden	3VA maximum
Overload	1.2 x rating continuously, 1.5 x rating for 10 seconds
Set Point Repeatability	>0.5% of full span
Differential (Hysteresis)	Preset at 1%. Values 1% to 15% available on request
Trip Level Adjustment	Low trip: 0 to 80% High trip: 40 to 120%
Time Delay Adjustable	0 to 10 seconds
AC Auxiliary Supply Voltage	100V, 110V, 120V, 208V, 220V, 240V, 480V, ±20%
DC Auxiliary Supply Voltage	12V, 24V, 48V, 110V or 125V, ±15%. Max ripple 15%
Auxiliary Voltage Burden	4VA (max)
Output Relay	Double pole change over
Relay Contact Rating	AC: 240V 5A, non inductive DC: 24V, 5A resistive
Relay Mechanical Life	0.2 million operations at rated loads
Relay Reset	Automatic
Operating Temperature	0°C to +60°C (0°C to +40°C for UL models)
Storage Temperature	-20°C to +70°C
Temperature Co-efficient	0.05% per °C
Interference Immunity	Electrical stress surge withstand and non-function to ANSI/IEEE C37 90a
Enclosure Style	DIN rail with wall mounting facility
Material	Flame retardant polycarbonate/ABS
Enclosure Integrity	IP50
Compliant With	EMC, LVD, Safety Standard IEC 414 UL File No: E113067 recognised up to 600V CSA File No: LR52592 up to 240V AC
Model 252 Dimensions	55mm (2.2") wide x 70mm (2.8") high x 112mm (4.4") deep
Model 253 Dimensions	75mm (2.9") wide x 70mm (2.8") high x 112mm (4.4") deep
Weight	Model 252: 0.4Kg approx. Model 253: 0.6Kg approx

Connections

252-PBB
252-PBA

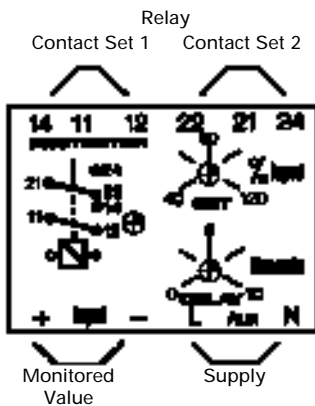

253-PBV

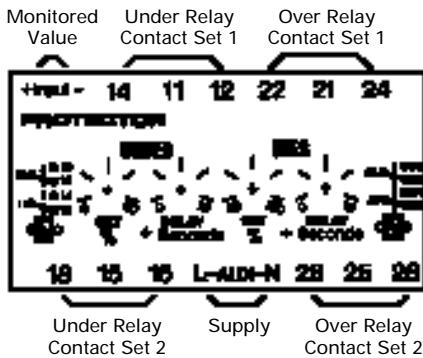

Dimensions

Model 252

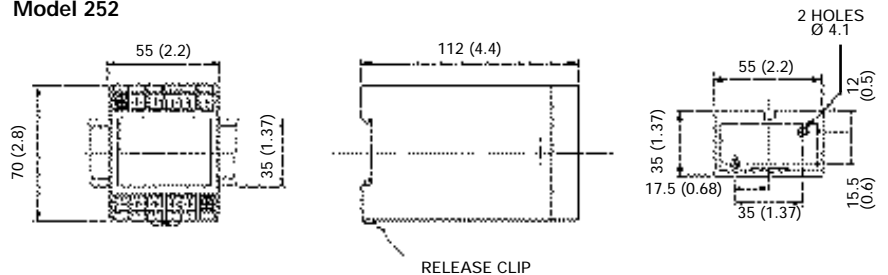

Model 253

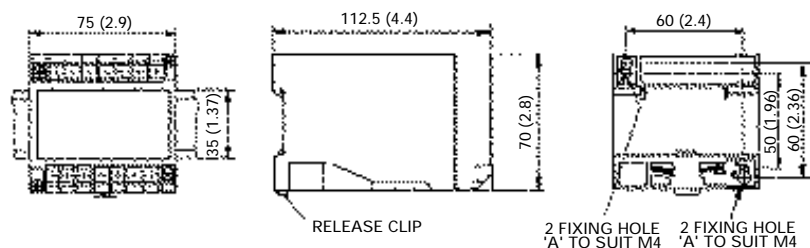



Speed Sensing

The 250 series speed sensing relay monitors rotating equipment and provides three output contacts which can be used to initiate alarm or shutdown signals. The relay also provides a tachometer output for speed indication. Speed sensing relays are ideally suited for engine and gas turbine monitoring and the protection of generator sets.

Operation

The speed sensing protector monitors the speed of rotation using a low cost magnetic pickup. Speed sensors are often used in generator set engines, gas turbines, motors, gear boxes or any rotating machines. The relay will detect under speed, over speed and stopped conditions, and the setpoint relays can be used to raise an alarm or shut down the equipment. The relay provides three user adjustable trip levels with LED relay state indication and a speed indicator output signal.

The product also offers an analogue output that can be used to monitor or display the speed. The product operates from the 12V or 24V dc battery supply, and speed is measured and calculated from the number of sensor pulses per revolution. Since the sensor is magnetic, a rotating steel component can be used, such as the flywheel which has gear teeth. This will result in a large number of pulses per revolution, and lead to greater accuracy.

The protector continuously monitors the rotation speed, and updates the analogue output signal. An output of 0.75 mA indicates normal speed (100%) while 1mA indicates 133% of nominal speed. The calibration point can easily be user adjusted. Three setpoint control adjustments allow setting of the desired speed limits for cranking, under speed and over speed.

Cranking Relay

The cranking relay detects if the engine is running or stopped. This relay can be used to ensure the cranking motor is disconnected once the engine has started running. Set the cranking setpoint just above the cranking motor speed. A red LED illuminates when the relay is energised, indicating a trip condition. The crank relay will only reset when the input frequency falls below 20% of the crank set point.

Under Speed Relay

The under speed relay detects when the normal running speed has been achieved. This can be used to enable the generator's electrical protection. It can also be used to trigger load shedding. A red LED illuminates when an under speed condition exists.

Over Speed Relay

The overspeed relay detects a stuck throttle or overshoot, a break in the sensor load will de-energise the over speed relay and can be used to shut down the engine. A red LED indicates over speed trip.

Fail Safe Operation

The relay will detect an open circuit speed sensor, and de-energise the overspeed relay.

Product Codes

Relay	Protection	ANSI No.	Catalogue No.
Speed Sensing	Crank 10 to 50% Under speed 50 to 100% Over speed 100 to 130%	12/14	253-PH3

When ordering please supply the following information:

- The number of pulses per revolution, e.g. flywheel teeth = 30.
- The nominal running speed, e.g. 3600 RPM.
- The DC battery supply, e.g. 24 V dc.

The protector speed sensing relay provides three user adjustable trip levels with LED relay state indication and a speed indicator output signal. Please specify:

- SP1 - disengages the crank starter.
- SP2 - energises protection or under-speed alarm.
- SP3 - alarms or trips on overspeed.

Features

- 1mA analogue output
- 3 adjustable setpoints
- Adjustable time delay
- Internal differential
- LED trip indication
- Automatic reset
- 3 single pole relays
- Magnetic pick up input

Benefits

- Under/over speed monitoring
- Speed indicator output signal
- Zero reset cranking
- Nuisance tripping avoidance
- Customised options

Applications

- Marine panels
- Switchgear
- Distribution systems
- Generator sets
- Control panels
- Process control
- Motor protection
- Transformers
- Overload protection

Approvals

- UL recognised



Connections

253-PH3

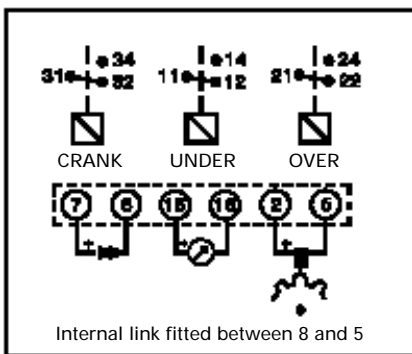

Specification – Speed Sensing

Pulse Input (Magnetic Input)	5V – 75V peak to peak
Frequency Input	0-1 to 0-10kHz
Overload	1.2 x rating continuously
Set Point Repeatability	>0.5% of full span
Differential (Hysteresis)	Preset at 2% (SP1 version resets at 20% of setting)
Trip Level Adjustment	SP1 (crank): 10% to 50% SP2 (under speed) : 50% to 100% SP3 (over speed) 100% to 130%
AC Auxiliary Supply Voltage	100V, 110V, 120V, 208V, 220V, 240V, 480V, ±20%
DC Auxiliary Supply Voltage	12V or 24V ±20%
Auxiliary Voltage Burden	3VA (max)
Analogue Output	0.75mA for normal 100% speed. 1mA for 133% of nominal speed
Calibration Signal	0-1mA into 0-1000 ohms
Output Relay	3 single pole change over relays
Relay Contact Rating	AC: 240V 5A, non inductive DC: 24V, 5A resistive
Relay Mechanical Life	0.2 million operations at rated loads
Relay Reset	Automatic
Operating Temperature	0°C to +60°C (0°C to +40°C for UL models)
Storage Temperature	-20°C to + 70°C
Temperature Co-efficient	0.05% per °C
Interference Immunity	Electrical stress surge withstand and non-function to ANSI/IEEE C37 90a
Enclosure Style	DIN rail with wall mounting facility
Material	Flame retardant polycarbonate/ABS
Enclosure Integrity	IP50
Compliant With	EMC, LVD, Safety Standard IEC 414 UL File No: E113067 recognised up to 600V
Model 253 Dimensions	75mm (2.9") wide x 70mm (2.8") high x 112mm (4.4") deep
Weight	0.6Kg approx

Dimensions

Model 253

